

SMART PRESSURE TRANSMITTER APC-2000ALW

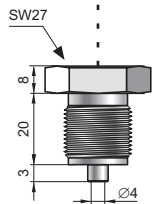

- ✓ 4...20 mA output signal + HART 5 / HART 7 protocol (special version: 0...20 mA or 0...5 mA output signal + HART 5 protocol)
- ✓ Display with backlight
- ✓ Programmable range, zero shift, characteristic and damping ratio with local panel keys
- ✓ Safety version SIL2/SIL3
- ✓ Intrinsic safety certificate ATEX, IECEx, FM (USA, Canada), INMETRO (Brazil), UKEX (UK), KCS (Korea)
- ✓ Explosion proof certificate ATEX, IECEx, FM (USA, Canada), INMETRO (Brazil), UKEX (UK), KCS (Korea)
- ✓ Marine certificate – DNV, BV
- ✓ Accuracy 0,075% (0,05%, 0,04% on request)
- ✓ Gold plated diaphragm (Au)
- ✓ MID (Measuring Instruments Directive) – certificate acc. to 2014/32/EU directive

up to 5 years warranty

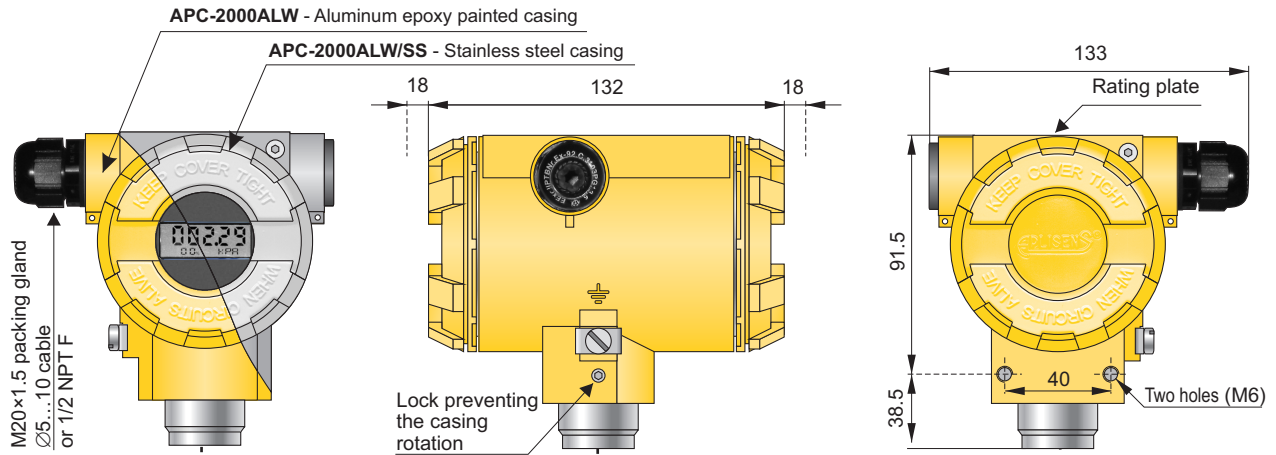

**G1/2 type
M type**
G1/2", Ø4 hole
M20x1.5, Ø4 hole

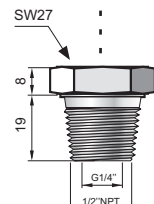

1/2"NPT M type
1/2"NPT male +
internal thread G1/4"

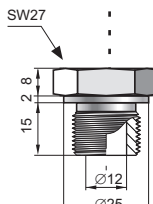

**GP type
P type**
G1/2", Ø12 hole
M20x1.5, Ø12 hole

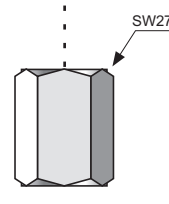

1/2"NPT F type
internal thread
1/2-14NPT

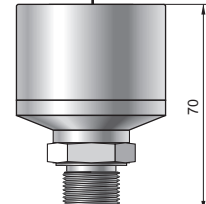

**GP type
P type**
1/2"NPT M type
for HS version

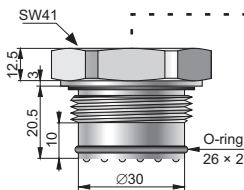

CG1 type
G1" with flush diaphragm

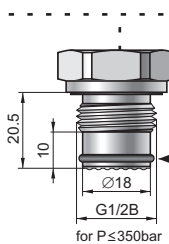

CG1/2 type
G1/2" with flush diaphragm

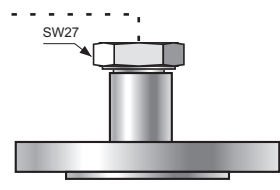
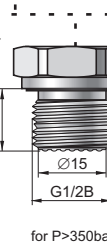

**Version with direct or remote
diaphragm seal**
Diaphragm seal data -
see chapter III

Application and construction

Smart pressure transmitters are applicable to the measurement of the pressure, underpressure and absolute pressure of gases, vapours and liquids. The active sensing element is a piezoresistant silicon sensor separated from the medium by a diaphragm and by specially selected type of manometric liquid. The casing is made of aluminium alloy cast or 316SS stainless steel, degree of protection IP66/IP67. The design of the casing enables the use of a local display, rotation of the display, rotation of the casing by 0–340° relative to the sensor, and a choice of cable direction.

The communication standard for data interchange with the transmitter is the Hart protocol.

Communication with the transmitter is carried out with:

- a KAP-03, KAP-03Ex communicator
- some other Hart type communicators, (*)
- a PC using an HART/USB converter and Report 2 configuration software.

(*) .eddl files available on www.aplisens.com.

The data interchange with the transmitter enables users to:

- ◆ identify the transmitter
- ◆ configure the output parameters:
 - measurement units and the values of the start points and end points at the measurement range
 - damping time constant
 - conversion characteristic (inversion, user's non-linear characteristic)
- ◆ read the currently measured pressure value of the output current and the percentage output control level
- ◆ force an output current with a set value
- ◆ calibrate the transmitter in relation to a model pressure

Installation

The transmitter can be installed directly on the installation. An universal mounting bracket is provided to transmitter fitting on 2" pipe (the AL mounting bracket, see page IV/5). When the pressure of steam or other hot media is measured, a siphon or impulse line should be used. The needle valve placed upstream the transmitter simplifies installation process and enables the zero point adjustment or the transmitter replacement. When the special process connections are required for the measurement of levels and pressures (e.g. at food and chemical industries), the transmitter is provided with an Aplisens diaphragm seal. Installing accessories and a full scope of diaphragm seals are described in detail in the further part of the catalogue. The transmitter's electrical connections should be performed with twisted cable. The place for the communicator should be assigned before the communicator installation.

Measuring ranges

| No. | Nominal measuring range (FSO) | | Minimum set range | | Rangeability | Overpressure limit (without hysteresis)**** | |
|-----|-------------------------------|-------------------|-------------------|---------------|--------------|---|-----------|
| 1 | 0...1000 bar | (0...100 MPa) | 10 bar | (1 MPa) | 100:1 | 1200 bar | (120 MPa) |
| 2 | 0...600 bar | (0...60 MPa) | 6 bar | (600 kPa) | 100:1 | 1000 bar | (100 MPa) |
| 3 | 0...300 bar ** | (0...30 MPa) | 3 bar | (300 kPa) | 100:1 | 450 bar | (45 MPa) |
| 4 | 0...160 bar ** | (0...16 MPa) | 1,6 bar | (160 kPa) | 100:1 | 450 bar | (45 MPa) |
| 5 | 0...70 bar ** | (0...7 MPa) | 0,7 bar | (70 kPa) | 100:1 | 140 bar | (14 MPa) |
| 6 | -1...70 bar ** | (-0,1...7 MPa) | 0,71 bar | (71 kPa) | 100:1 | 140 bar | (14 MPa) |
| 7 | 0...25 bar ** | (0...2,5 MPa) | 0,25 bar | (25 kPa) | 100:1 | 50 bar | (5 MPa) |
| 8 | -1...25 bar ** | (-0,1...2,5 MPa) | 0,26 bar | (26 kPa) | 100:1 | 50 bar | (5 MPa) |
| 9 | 0...7 bar ** | (0...0,7 MPa) | 0,07 bar | (7 kPa) | 100:1 | 14 bar | (1,4 MPa) |
| 10 | -1...7 bar ** | (-100...700 kPa) | 0,08 bar | (8 kPa) | 100:1 | 14 bar | (1,4 MPa) |
| 11 | -1...1,5 bar ** | (-100...150 kPa) | 0,12 bar | (12 kPa) | 20:1 | 4 bar | (400 kPa) |
| 12 | 0...2 bar ** | (0...200 kPa) | 100 mbar | (10 kPa) | 20:1 | 4 bar | (400 kPa) |
| 13 | 0...1 bar ** | (0...100 kPa) | 50 mbar | (5 kPa) | 20:1 | 2 bar | (200 kPa) |
| 14 | -0,5...0,5 bar ** | (-50...50 kPa) | 50 mbar | (5 kPa) | 20:1 | 2 bar | (200 kPa) |
| 15 | 0...0,25 bar ** | (0...25 kPa) | 25 mbar | (2,5 kPa) | 10:1 | 1 bar | (100 kPa) |
| 16 | -100...100 mbar ** | (-10...10 kPa) | 20 mbar | (2 kPa) | 10:1 | 1 bar | (100 kPa) |
| 17 | -15...70 mbar **/** | (-1,5...7 kPa) | 5 mbar | (0,5 kPa) | 17:1 | 0,5 bar | (50 kPa) |
| 18 | -25...25 mbar **/** | (-2,5...2,5 kPa) | 2 mbar | (0,2 kPa) | 25:1 | 0,5 bar | (50 kPa) |
| 19 | -7...7 mbar **/** | (-0,7...0,7 kPa) | 1 mbar | (0,1 kPa) | 14:1 | 0,5 bar | (50 kPa) |
| 20 | 0...1,3 bar abs | (0...130 kPa abs) | 100 mbar abs | (10 kPa abs) | 13:1 | 2 bar | (200 kPa) |
| 21 | 0...7 bar abs | (0...0,7 MPa abs) | 100 mbar abs | (10 kPa abs) | 70:1 | 14 bar | (1,4 MPa) |
| 22 | 0...25 bar abs | (0...2,5 MPa abs) | 0,25 bar abs | (25 kPa abs) | 100:1 | 50 bar | (5 MPa) |
| 23 | 0...70 bar abs | (0...7 MPa abs) | 0,7 bar abs | (70 kPa abs) | 100:1 | 140 bar | (14 MPa) |
| 24 | 0...300 bar abs | (0...30 MPa abs) | 3 bar abs | (300 kPa abs) | 100:1 | 450 bar | (45 MPa) |

* transmitters not available with diaphragm seal;

explosion proof version - available only Exd (2G)

** transmitters available in HS version

*** transmitters available only in HS version

**** overpressure limit can be different for version according to 2014/68/EU PED

Technical data

Metrological parameters

Accuracy ≤ ±0,075% of the calibrated range
(≤ ±0,1% for range no. 19)

Special version: ≤ ±0,05% of the calibrated range
(≤ ±0,04%, ≤ ±0,025% on request)

Long-term stability ≤ accuracy for 3 years
(for the nominal measuring range) or ≤ 2 x accuracy for 5 years

HS version (ranges 3+15): ≤ accuracy for 6 years
or ≤ 2 x accuracy for 10 years

Thermal error < ±0,05% (FSO) / 10°C
(0,1% for ranges no. 16+19)

max. ±0,25% (FSO) in the whole compensation range
(0,4% for ranges no. 16+19)

Thermal compensation range -25...80°C

Special version: -40...80°C

Additional electronic damping 0...60 s

Error due to supply voltage changes 0,002% (FSO) / V

Electrical parameters

| Version | Power supply |
|------------------------------------|-------------------------------|
| standard | 10...55 VDC |
| Exia | 10,5...30 VDC |
| IS(...) | 11,5...30 VDC |
| Exd, XP(...) | 13,5...55 VDC |
| Exia/Exd, IS/XP(...) | 11,5...30 VDC / 11,5...55 VDC |
| Safety, Safety Exd, Safety XP(...) | 11,5...36 VDC |
| Safety Exia, Safety IS(...) | 11,5...30 VDC |
| Safety Exia/Exd, Safety IS/XP(...) | 11,5...30 VDC / 11,5...36 VDC |
| MID Exia | 13,5...28 VDC |
| MID Exd | 13,5...45 VDC |

Output signal 4...20 mA + HART

Load resistance (for standard version) $R[\Omega] \leq \frac{U_{supl}[V] - 10V}{0,0225A}$

Resistance required for communication min. 240 Ω

Materials

Wetted parts and diaphragms: 316Lss, Hastelloy C 276, Au
Casing: Aluminum, 316SS
Material of window: hardened glass

Operating conditions

Operating temperature range (ambient temp.)
 -40...85°C (Safety: -25...85°C)
 Exia, IS version -40...80°C (Safety: -25...80°C)
 Exd, XP version -40...75°C (Safety: -25...75°C)
Medium temperature range -40...120°C
 Safety: -40...85°C
 PED: -40...100°C

over 120°C – measurement with use an impulse line or diaphragm seal

CAUTION: the medium must not be allowed to freeze in the impulse line or close to the process connection of the transmitter

Accuracy depending on the set range

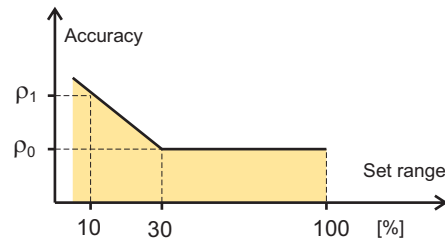

ρ_0 – error for range 30...100% FSO

ρ_1 – error for range 10% FSO

$$\rho_1 = 2 \times \rho_0$$

Numerical error values are given in the technical data under metrological parameters

SMART PRESSURE TRANSMITTER APC-2000ALW version with MID

Application

Smart pressure transmitter APC-2000ALW MID is applicable to the measurement of the pressure and absolute pressure in application designed according to directive 2014/32/EU (MID), harmonized standard EN 12405-1:2018 Annex B. Device subcomponent suitable for custody transfer measurement of gas with MID approval. Mechanical construction and installation of the transmitter enclosure shall comply with the transmitter APC-2000ALW are described on page I/ 3 of catalogue. Pressure transmitters APC-2000ALW MID are produced only with nominal ranges according to the table. Transmitter due to factory blockage of transmitter's configuration cannot be configurable by user. Electrical connection of the transmitter is according to drawing on page I/ 3. Available are only terminals SIGNAL + and SIGNAL -.

Metrological parameters

Max. permissible error according to EN12405-1 (calculated in relation to the measured value)

- in reference conditions $\leq 0,2\%$
- nominal operating conditions $\leq 0,5\%$
- special version $\leq 0,3\%$

Long-term stability $< 0,5\% / 5$ years

Operating temperature range -25...55°C

Power supply Exia: 13,5...28 VDC

Exd: 13,5...45 VDC

MID Parts Certificate No. 27/12

Measuring ranges

| Nominal measuring range | | Overpressure limit (without hysteresis) | |
|-------------------------|--------------------|---|-----------|
| 10+100 bar ABS | (1+10 MPa ABS) | 160 bar | (16 MPa) |
| 2+20 bar ABS | (0,2+2 MPa ABS) | 50 bar | (5 MPa) |
| 2+20 bar | (0,2+2 MPa) | 50 bar | (5 MPa) |
| 0,9+7 bar ABS | (0,09+0,7 MPa ABS) | 14 bar | (1,4 MPa) |
| 0,9+7 bar | (0,09+0,7 MPa) | 14 bar | (1,4 MPa) |

Ordering procedure of MID version

| Model | Code | Description |
|-------------------------|---|--|
| APC-2000 | | Smart pressure transmitter |
| Casing, output signal | /ALW..... | Aluminum housing, IP66/IP67, with display, output 4-20mA + Hart |
| | /MID..... | MID – certificate acc. to 2014/32/EU directive |
| Versions, certificates | /Exia..... /Exd..... | II 1/2G Ex ia IIC T4/T5 Ga/Gb, II 1 D Ex ia IIIC T105°C Da II 1/2G Ex ia/db IIC T5/T6 Ga/Gb, II 1/2D Ex ia/tb IIIC T85°C /T100°C Da/Db |
| Nominal measuring range | /10+100 bar ABS /2+20 bar ABS /2+20 bar /0,9+7 bar ABS /0,9+7 bar | 10+100 bar ABS (1+10 MPa ABS) with possibility of changing, min. range 10+70 bar ABS (1+7 MPa ABS) 2+20 bar ABS (0,2+2 MPa ABS) 2+20 bar (0,2+2 MPa) 0,9+7 bar ABS (0,09+0,7 MPa ABS) 0,9+7 bar (0,09+0,7 MPa) |
| Process connections | /M..... /G1/2..... /G1/2(Au)..... /P..... /GP..... /1/2"NPTM..... /1/2"NPTF..... | Thread M20x1,5 (male) with $\varnothing 4$ hole, wetted parts SS316L Thread G1/2" (male) with $\varnothing 4$ hole, wetted parts SS316L Thread G1/2" (male) with $\varnothing 4$ hole, gold plated diaphragm Thread M20x1,5 (male) with $\varnothing 12$ hole, wetted parts SS316L Thread G1/2" (male) with $\varnothing 12$ hole, wetted parts SS316L Thread 1/2"NPT Male, wetted parts SS316L Thread M20x1,5 with adapter to 1/2"NPT Female, wetted parts SS316L |
| Electrical connection | (without marking) /US..... | Packing gland M20x1,5 Thread 1/2"NPT Female |
| Accessories | /AL..... /AL(SS)..... /ST..... /MT..... | Mounting bracket type AL for 2" pipe, material zinc steel Mounting bracket type AL for 2" pipe, material stainless steel Stainless Steel plate riveted to the housing Stainless Steel Tag plate mounted on wire |

Ordering procedure

| Model | Code | Description |
|------------------------|--|---|
| APC-2000 | | Smart pressure transmitter |
| Versions | /ALW..... /ALW/Safety..... | With display, output 4-20mA + Hart With display, output 4-20mA + Hart Functional Safety certificate according to PN-EN 61508:2010 parts 1 + 7, PN-EN 61511-1:2017 + PN-EN 61511-1:2017/A1:2018-03, PN-EN 62061:2008 + PN-EN 62061:2008/A1:2013-06 + PN-EN 62061:2008/A2:2016-01 |
| Certificates, options* | /SS..... /Exia..... | Stainless steel housing II 1/2G Ex ia IIC T4/T5 Ga/Gb IECEx Ex ia IIC T4/T5 Ga/Gb |
| | /Exia (Da)..... | II 1/2G Ex ia IIC T4/T5 Ga/Gb II 1D Ex ia IIIC T115°C Da I M1 Ex ia I Ma (version with SS housing) Ex ia IIC T4/T5 Ga/Gb IECEx Ex ia IIIC T115°C Da Ex ia I Ma (version with SS housing) |
| | /IS..... | IS Class I, Div 1, Groups A, B, C, D T4 IS Class II, Div 1, Groups E, F, G T5 IS Class III, Div 1, T5 Zone 0 AEx/Ex ia IIC T4 Ga Zone 20 AEx/Ex ia IIIC T105°C Da |
| | /ISB..... | Ex ia IIC T5/T4 Ga/Gb Ex ia IIIC T105°C Da Ex ia I Ma (version with SS housing) |
| | /ISK..... | Ex ia IIC T5/T4 Ga/Gb Ex ia IIIC T105°C Da |
| | /ISUK..... | II 1/2 G Ex ia IIC T5/T4 Ga/Gb II 1 D Ex ia IIIC T105°C Da I M1 Ex ia I Ma (version with SS housing) |
| | /Exd..... | II 1/2G Ex ia/db IIC T6/T5 Ga/Gb II 1/2D Ex ia/tb IIIC T105°C Da/Db I M2 Exd ia I Mb (version with SS housing) Ex ia/db IIC T6/T5 Ga/Gb IECEx Ex ia/tb IIIC T105°C Da/Db Ex db ia I Mb (version with SS housing) Packing gland available on request |
| | /Exd (2G)..... | II 2G Ex db ia IIC T6/T5 Gb II 2D Ex ia tb IIIC T105°C Db Ex db ia IIC T6/T5 Gb IECEx Ex ia tb IIIC T105°C Db Packing gland available on request |
| | /XP..... | XP Class I, Div 1, Groups A, B, C, D T5 DIP Class II, Div 1, Groups E, F, G T5 DIP Class III, Div 1, T5 Zone 1 AEx db ia IIC T5 Gb Zone 21 AEx ia tb IIIC T105°C Db Packing gland available on request |
| | /XPC..... | XP Class I, Div 1, Groups B, C, D T5 DIP Class II, Div 1, Groups E, F, G T5 DIP Class III, Div 1, T5 Zone 1 AEx/Ex db ia IIC T5 Gb Zone 21 AEx/Ex ia tb IIIC T105°C Db Packing gland available on request |
| | /XPB..... | Ex ia/db IIC T6/T5 Ga/Gb Ex ia/tb IIIC T105°C Da/Db Ex db ia I Mb (version with SS housing) Packing gland available on request |
| | /XPK..... | Ex ia/db IIC T6/T5 Ga/Gb Ex ia/tb IIIC T105°C Da/Db Packing gland available on request |
| | /XPUK..... | II 1/2 G Ex ia/db IIC T6/T5 Ga/Gb II 1/2 D Ex ia/tb IIIC T105°C Da/Db I M2 Ex db ia I Mb (version with SS housing) Packing gland available on request |
| | /Exia(Da)/Exd..... | not available for ranges no. 17+19 Dual certification Exia(Da) and Exd |
| | /Exia(Da)/Exd(2G)..... | Dual certification Exia(Da) and Exd(2G) |
| | /IS/XP..... | Dual certification IS and XP and for US |
| | /IS/XPC..... | Dual certification IS and XPC for US and Canada |
| | /ISB/XPB..... | Dual certification IS and XP and for Brazil |
| | /ISK/XPK..... | Dual certification IS and XP and for Korea |
| | /ISUK/XPUK..... | Dual certification IS and XP and for United Kingdom |
| /SA..... | Surge arrester for Exia version | |
| /HS..... | Ultra stable version (only ranges no. 3+19, process connection: P, GP, 1/2"NPTM) | |
| /0,05%..... | Accuracy $\leq \pm 0,05\%$ | |
| /MR..... | Marine certificate – DNV, BV | |
| /Tlen..... | For oxygen service (sensor filled with Fluorolube fluid), only G1/2" connection | |
| /-40...80°C..... | Extended thermal compensation range -40 + 80°C | |
| /IP67..... | Protection class IP67 | |
| /NACE..... | NACE MR-01-75 certificate (process connections: M, G1/2", P, GP and 1/2"NPTM) | |
| /PED..... | PED category I | |
| /Hart 7..... | Communication protocol HART in revision 7 | |

* more than one option is available

See next page

| Code | | Description | |
|-------------------------|-------------------------------|---|-------------------------------------|
| | | Range | Min. set range |
| Nominal measuring range | /0÷1000 bar..... | 0÷1000 bar (0÷100 MPa) | 10 bar (1 MPa) |
| | /0÷600 bar..... | 0÷600 bar (0÷60 MPa) | 6 bar (600 kPa) |
| | /0÷300 bar..... | 0÷300 bar (0÷30 MPa) | 3 bar (300 kPa) |
| | /0÷160 bar..... | 0÷160 bar (0÷16 MPa) | 1,6 bar (160 kPa) |
| | /0÷70 bar..... | 0÷70 bar (0÷7 MPa) | 0,7 bar (70 kPa) |
| | /-1÷70 bar..... | -1÷70 bar (-0,1÷7 MPa) | 0,71 bar (71 kPa) |
| | /0÷25 bar..... | 0÷25 bar (0÷2,5 MPa) | 0,25 bar (25 kPa) |
| | /-1÷25 bar..... | -1÷25 bar (-0,1÷2,5 MPa) | 0,26 bar (26 kPa) |
| | /0÷7 bar..... | 0÷7 bar (0÷700 kPa) | 0,07 bar (7 kPa) |
| | /-1÷7 bar..... | -1÷7 bar (-100÷700 kPa) | 0,07 bar (7 kPa) |
| | /-1÷1,5 bar..... | -1÷1,5 bar (-100÷150 kPa) | 120 mbar (12 kPa) |
| | /0÷2 bar..... | 0÷2 bar (0÷200 kPa) | 100 mbar (10 kPa) |
| | /0÷1 bar..... | 0÷1 bar (0÷100 kPa) | 50 mbar (5 kPa) |
| | /-0,5÷0,5 bar..... | -0,5÷0,5 bar (-50÷50k Pa) | 50 mbar (5 kPa) |
| | /0÷0,25 bar..... | 0÷0,25 bar (0÷25 kPa) | 25 mbar (2,5 kPa) |
| | /-100÷100 mbar..... | -100÷100 mbar (-10÷10 kPa) | 20 mbar (2 kPa) |
| | /-15÷70 mbar..... | -15÷70 mbar (-1,5÷7 kPa) | 5 mbar (0,5 kPa) |
| | /-25÷25 mbar..... | -25÷25 mbar (-2,5÷2,5 kPa) | 2 mbar (0,2 kPa) |
| /-7÷7 mbar..... | -7÷7 mbar (-0,7÷0,7 kPa) | 1 mbar (0,1 kPa) | |
| /0÷1,3 bar ABS..... | 0÷1,3 bar ABS (0÷130 kPa ABS) | 0,1 bar ABS (10 kPa ABS) | |
| /0÷7 bar ABS..... | 0÷7 bar ABS (0÷700 kPa ABS) | 0,1 bar ABS (10 kPa ABS) | |
| /0÷25 bar ABS..... | 0÷25 bar ABS (0÷2,5 MPa ABS) | 0,25 bar ABS (25 kPa ABS) | |
| /0÷70 bar ABS..... | 0÷70 bar ABS (0÷7 MPa ABS) | 0,7 bar ABS (70 kPa ABS) | |
| /0÷300 bar ABS..... | 0÷300 bar ABS (0÷30 MPa ABS) | 0,3 bar ABS (30 kPa ABS) | |
| Measuring set range | /...+... [required units] | Calibrated range in relation to 4mA and 20mA output | |
| | /M..... | Thread M20x1,5 (male) with Ø12 hole, wetted parts SS316L | } Not available with range no. 1, 2 |
| | /G1/2..... | Thread G1/2" (male) with Ø4 hole, wetted parts SS316L | |
| | /G1/2(Au)..... | Thread G1/2" (male) with Ø4 hole, gold plated diaphragm (Ranges no. 1, 2, 3, 4, 5) | |
| | /P..... | Thread M20x1,5 (male) with Ø12 hole, wetted parts SS316L | |
| | /GP..... | Thread G1/2" (male) with Ø12 hole, wetted parts SS316L | |
| | /GP(Hastelloy)..... | Thread G1/2" (male) with Ø12 hole, wetted parts Hastelloy C 276 | |
| | /CG1"..... | Thread G1" with flush diaphragm, wetted parts SS316L (Pressure limits: min. 0,1bar / max. 70bar) | |
| | /CG1"(Hastelloy)..... | Thread G1" with flush diaphragm, wetted parts Hastelloy C 276 (Pressure limits: min. 0,1bar / max. 70bar) | |
| | /CG1/2"..... | Thread G1/2" with flush diaphragm, wetted parts SS316L (Pressure limits: min. 2,5bar) | |
| | /1/2"NPTM..... | Thread 1/2"NPT Male, G1/4" Female, wetted parts SS316L (Pressure limits: 1/2"NPT Male max. 690bar, G1/4" Female max. 1000bar) | |
| | /1/2"NPTM(Hastelloy)..... | Thread 1/2"NPT Male, G1/4" Female, wetted parts Hastelloy C 276 (Ranges no. 3, 4, 5, 7, 9) | |
| | /1/2"NPTF..... | Thread G1/2" or M20x1,5 with adapter to 1/2"NPT Female, wetted parts SS316L (Pressure limits: max. 690bar) | |
| | /code of diaphragm seal..... | Diaphragm seal (see chapter of diaphragm seals) | |
| Electrical connection | (without marking) /US..... | Packing gland M20x1,5 Thread 1/2"NPT Female | |
| Accessories | /AL..... | Mounting bracket type AL for 2" pipe, material zincd steel | |
| | /AL(SS)..... | Mounting bracket type AL for 2" pipe, material ss304 | |
| | /AL(SS316)..... | Mounting bracket type AL for 2" pipe, material ss316 | |
| | /ST..... | Stainless Steel plate fixed to the housing | |
| | /MT..... | Stainless Steel Tag plate mounted on wire | |

Standard display configuration

| | Std. version | Exia, Exia(Da) | IS | Exd | XP | Exia(Da)/Exd, IS/XP | Safety | MID |
|---------------|--------------|----------------|----|-----|----|---------------------|--------|-----|
| Backlight on | • | • | | • | | | | • |
| Backlight off | | | • | | • | • | • | |

Other configuration of display has to be marked upon placing order. User has no possibility of switching backlight on/off.

Example: Pressure transmitter, output 4...20mA + HART, version Exia, nominal measuring range 0...7bar, calibrated range 0...6bar, process connection 1/2"NPT male, electrical connection 1/2"NPTF.

APC-2000ALW/Exia/0..7bar/0..6bar/1/2"NPTM/US