

CAM-335/530

Designed for fitting in automatic emergency intervention switchboards.

It is intended to control and command a generating set and to connect the user to the mains or genset.

USER INSTRUCTION MANUAL

Complete with backlit graphic touch-screen display

It shows:

- Single-phase generator voltmeter.
- Generator frequency meter.
- a genset tachometer.
- the battery voltmeter;
- the fuel level gauge;
- water oil thermometer (optional);
- oil pressure gauge (optional).
- the total hour meter;
- the partial hour meter;
- the start-up counter.



Functions

- Automatic monitoring of faults with messages on the display.
- Single-phase control of the generator set voltage (undervoltage, overvoltage, underfrequency and overfrequency).
- Texts in 7 languages: Italian, English, French, German, Spanish, Portuguese plus a programmable language.
- Management of 4 maintenance operations.
- Management of rental hours.
- Remote controls (start-up, stop, EJP).
- Possibility to start up genset when the battery is in low charge.
- Possibility to match inputs and outputs to different functions.
- Management of glow plug preheating.
- Clock-programmed start-up and stop of generator set.
- Programmable weekly self-test.
- Fault history.
- Possibility to program password-protected functions.

PARMA



ELCOS®

ITALY

Tel. +39 0521/772021 Fax +39 0521/270218
E-mail: info@elcos.it - HTTP://www.elcos.it

CONTENTS

CHRONOLOGY OF MANUAL REVISIONS	2
BRIEF INSTRUCTIONS	3
INSTRUMENTS	3
VIEW MODE	4
OPERATION	6
WIRING DIAGRAM	12
USER-PROGRAMMED FUNCTIONS	14
LIST OF FAULTS	17
TECHNICAL SPECIFICATIONS	18
WARNING/ERROR MESSAGES	19
DATA REQUIRED FOR ORDERS	20

CHRONOLOGY OF MANUAL REVISIONS

Date	Revision	Description	Page
27/07/2015	1.00	First issue	
05/09/2016	1.05	Max. mains voltage present delay =9999 sec.	12 Programming manual
10/10/2016	1.06	Fault: radiator stops without cooling	8 Programming manual
19/12/2016	1.09	Semi-automatic mode, reset of maintenance cycle, acceptance of commands via SMS from any telephone number.	6, 16, 18 technical prog.
23/05/2017	1.10	<ul style="list-style-type: none"> • Exclusion of current transformers • Programming of maximum number of fault SMS messages • Keyboard error input • Programmable mains contactor fault input • Programmable genset contactor fault input 	5,12,18, 20 Technical prog.
	1.13	<ul style="list-style-type: none"> • Change automatic test 	1, 7, 3, 13 Technical prog.
04/06/2020	1.14	<ul style="list-style-type: none"> • Time synchronization of other control units. 	

BRIEF INSTRUCTIONS

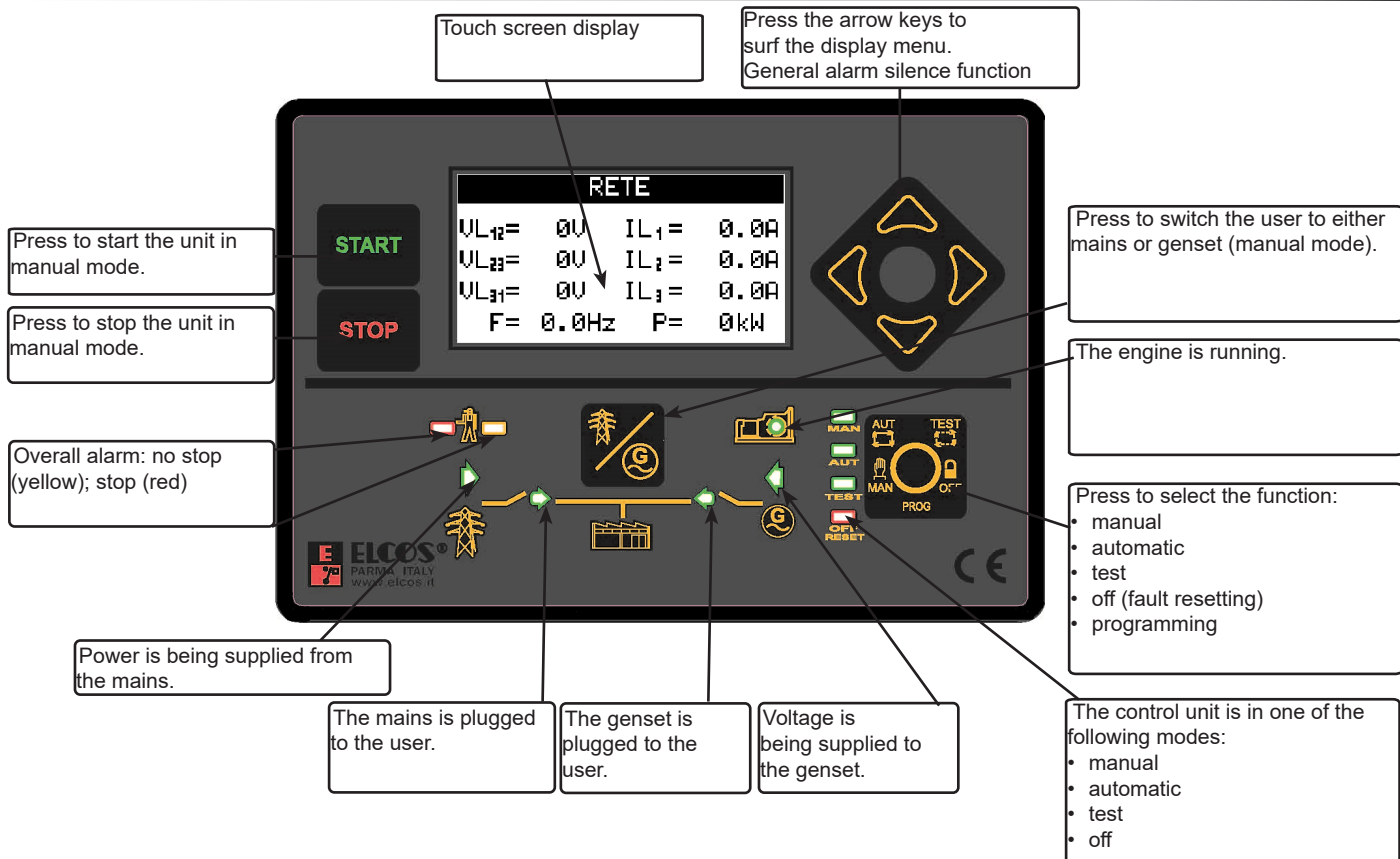

INSTRUMENTS

The control unit is supplied with a backlit graphic display (128 x 64 dot) featuring a touch screen. It is used to show the following instruments:



- Single-phase generator voltage.
- Generator frequency meter.
- Battery voltage.
- D+ voltage (pre-excitation alternator).
- Fuel tank level indicator.
- Engine temperature expressed in °C or °F.
- Oil pressure expressed in BAR or kPa.
- Engine revolutions (RPM).
- Total hour-meter.
- Partial hour-meter.
- Start-ups count.
- Starting failure counter.
- Maintenance expirations.
- Rental hour expiry.
- Clock and calende

All the electrical instruments of the genset and the engine instruments are displayed by one simple click on the relevant arrow key. If a fault occurs, the display shows a message to describe the fault.

VIEW MODE



The instruments displayed by the control unit are divided into groups. These groups are:

- Generator
- Engine instruments
- Counters
- Maintenance (if maintenance hours have been set)
- Rental (if rental hours have been set)
- Anomalies
- Clock
- Information about the control unit.

The two arrows   are used to scroll through the instrument groups on the display or to select the sub-menus under the settings.

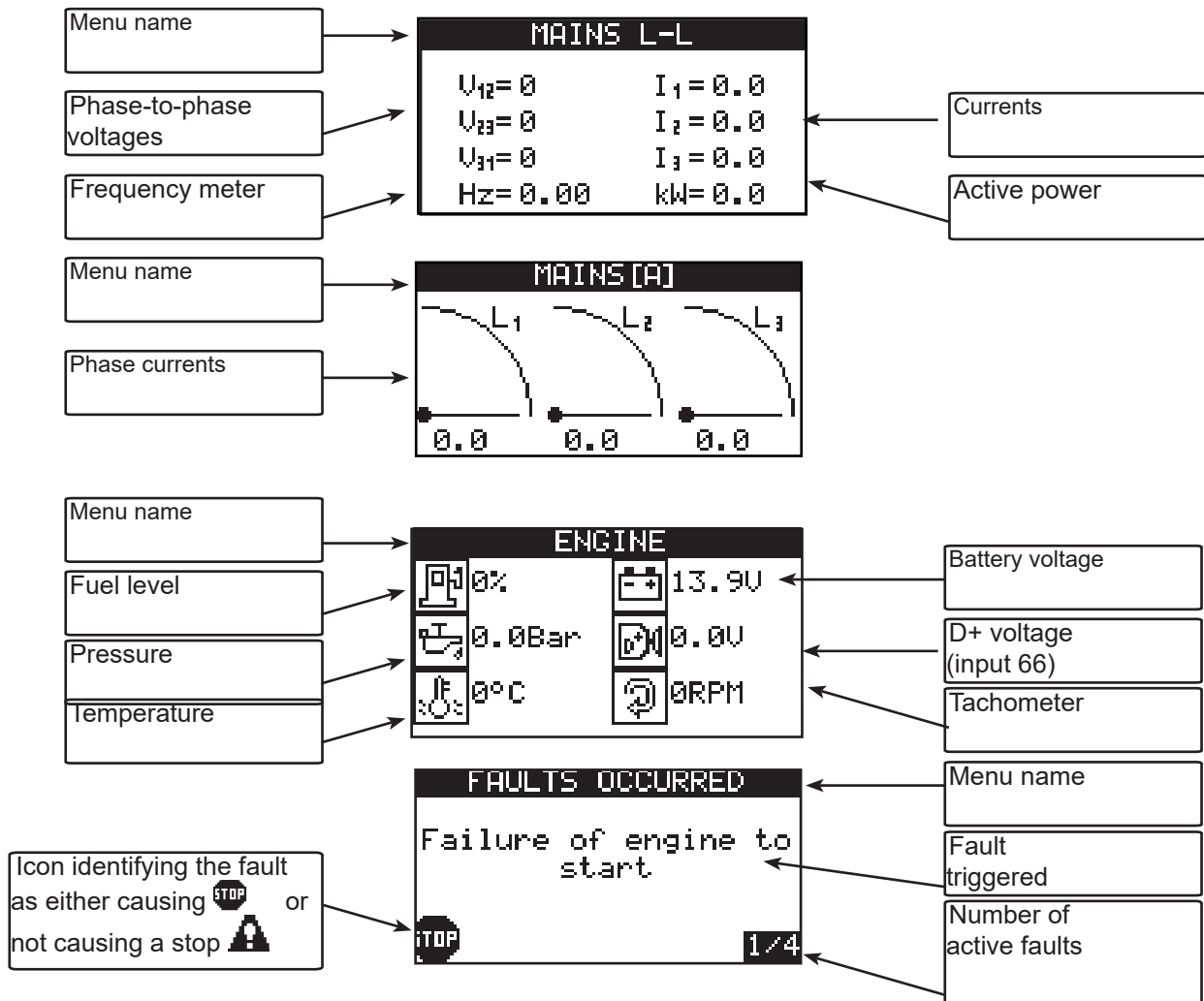
The following are a few examples of instrument display menus.



The two arrow keys  and  are used to move next and back within the groups of instruments or to scroll the selection elements in the programming menus.

To view the instruments individually, click the relevant instrument on the display. For example:

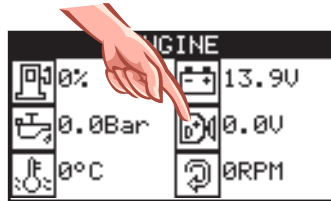

a finger click on icon D+

opens the menu where this instrument is displayed.

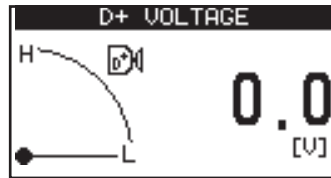

A click on the display and/or pressing of the arrow keys is enough to move next and back within the various groups of instruments. Each time the display is touched, the next instrument in the same group will be displayed. For example:

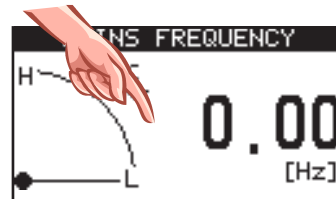
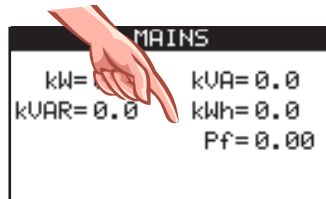
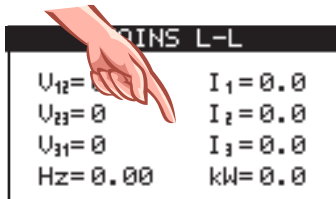

instruments are scrolled.

This is how all the

OPERATION

SELECTION OF FUNCTIONS



The function selected with this button is highlighted by turning on of the corresponding warning light.

MANUAL



This image appears when switching to manual mode.

START

STOP

Click button **START** to start up and button **STOP** to stop (a tap on the button is sufficient).



Press button  to switch from mains to genset and vice versa.

There are two possible options to program the protection function of the generator set in manual mode:

- the triggered fault is displayed and the engine is stopped (this is the programming option selected for the control unit);
- the triggered fault is displayed, but the engine is not stopped. Faults originating from a genset overspeed and emergency are programmed to cause an engine stop: they must not be programmed without the engine stop.

AUTOMATIC



Image displayed when switched to automatic.

When a mains anomaly occurs — detected by external call delay has elapsed — the control unit commands the mains contactor to open and the genset to start. With the engine running and with correct generator voltage and frequency, once the G.S. VOLTAGE PRESENT DELAY has elapsed, the generator contactor is closed. When operating, the genset is protected from any anomalies.

When the mains voltage is restored and the MAINS VOLTAGE PRESENT DELAY has elapsed, the control unit commands the generator contactor to open and after the GENERATOR MAINS INTERLOCK time has elapsed, the mains contactor closes.

The COOLING TIME enables and facilitates subsequent engine cooling before it shuts down.

To facilitate start-up, a special circuit determines a series of start-up attempts, the number, pause duration and start-up duration of which can be programmed. If running of the entire series of start-up attempts is unable to start the engine, when the cycle is completed, STARTING FAILURE is displayed and the stop cycle starts.

TEST



This image appears when switching to test mode.

The engine start-up cycle in test mode is the same as in automatic mode, the exception being that mains still supplies power to the user. If a mains fault is experienced during the test, the control unit remains in test mode, but commands closing of the genset contactor.

OFF



This image appears when switching to OFF mode. When in OFF mode, the engine cannot be started in any way and, if it is running, it is stopped without cooling.

PROGRAMMABLE OUTPUTS

WARNING!

Outputs 5, 19 and 70 can be associated to many functions (see programming manual under the section "PROGRAMMABLE OUTPUTS"). It is NOT possible to simultaneously associate more than one function to an output. For example, if fuel filling is associated to output 70, it is not possible to manage the general alarm from this terminal and vice-versa. By default, management of glow plugs is associated to output 5, the signal that simulates the 15/54 to output 19, and the general alarm to output 70.

PREHEATING OF GLOW PLUGS

Activation of the glow plug output may be adjusted from min. 0 seconds (command disabled) to max. 60 seconds both in automatic and manual mode. The engine start-up procedure starts as soon as glow plug activation has been completed. The system also offers the possibility to manage glow plug post-heating, in other words to keep the output active for a programmable time after engine start-up (see Programming Manual).

The control unit can manage start-up of both diesel and petrol engines. For choice of engines, see the programming manual.

AUTOMATIC TEST

The automatic test is enabled only with the control unit on automatic. During the test, the generator set starts up and stays running for the AUTOMATIC TEST DURATION time (programmed at 3 minutes). If a mains anomaly occurs, the generator contactor closes. The display shows AUTOMATIC TEST during the test cycle. You can also choose whether to run a commutation or not during the test (default setting: no commutation). Press STOP to stop the engine during the test. The test will not be run if there is an anomaly. The automatic test can be performed in two ways:

- WEEKLY: the test will be run weekly at the time and on the day set.
- MEASURED: the test can be programmed to run at cycles ranging from 1 to 30 days. The default setting is 7 days. To enable the test, just enter User Programming and include the function. Once any one of the test parameters has been set, it starts for the first time when one minute after quitting the setting mode has elapsed. If at that time the conditions for starting the test are not present (e.g. because the control unit is not on automatic), the test will be run at the next deadline. The time count starts all over again when the control unit is reset.

DETECTION OF ENGINE RUNNING

Engine running is detected by revealing the residual generator frequency and voltage and by detecting the voltage and frequency of the battery charger alternator (permanent or pre-excitation magnets). Once detected, the starter motor switches off and the green LED lights up 

STOPPING SYSTEMS

The engine may be stopped in two ways:

- with an electromagnet or solenoid valve that is energized while the engine is running and de-energized while the engine is stopping (this is the factory-programmed option);
- with an electromagnet that is de-energized while the engine is running and energized while the engine is stopping: this condition persists throughout the entire STOP TIME after the "engine not running" condition has been detected. The FAILED ENGINE STOP fault triggers, if the control unit still detects the engine running signal 120 seconds after the stop command.

EMERGENCY STOP

An emergency stop can be enabled in any operating condition. One or more than one emergency button (latching) may be fitted for this purpose. This is an immediate stop, which does not result in engine cooling: it enables the general alarm and is shown on the display.

EMERGENCY STOP



Do not use the emergency stop button combined with a stop system which is not energized while the engine is running.

GENERAL ALARM

To manage the general alarm, an indicator is fitted in the alarm terminal. It can be programmed to come on continuously or for a preset time. It triggers any time a fault is detected by the control unit.



A click on any cursor keys





causes the alarm to be silenced.



GENSET AND USER PROTECTIONS

Tripping of an anomaly is shown on the display and can cause the engine to cut out and activates the general alarm. See the FAULT LIST table on page 17.

Normally the display shows the genset instruments; in the event of an anomaly, it displays the anomaly message triggered. If the anomaly causes a stop, the red LED flashes and the  icon lights up; if the anomaly does not cause a stop, the yellow LED flashes and the  icon lights up.

Press the  to review the instruments on the display and, at the same time, silence the general alarm, use one of

the 4  navigational arrows. After 20 seconds have elapsed since the last time the key was pressed, the display reverts back to displaying the anomaly/anomalies that have occurred.

When OFF RESET lights up, the anomalies  reset by pressing the key .

If the OFF function is disabled, press the  key to reset the anomalies.

PREVENTIVE MAINTENANCE

When periodic maintenance is required, the light  turns on intermittently and the display shows the number corresponding to the maintenance operation required, as previously scheduled, with a description. If scheduled, the stop occurs even if the MANUAL PROTECTIONS control is disabled and the DISABLE PROTECTIONS input is enabled. Resetting of any expired maintenance can only be performed by the generator set manufacturer.

RENTAL FUNCTION

This function enables programming of the rental hours of the generator set, after which the control unit either immediately stops operation of the genset or prevents the next start-up. When programmed, the stop occurs even if the MANUAL PROTECTIONS are disabled and the DISABLE PROTECTIONS input is enabled. The rental hours decrease as the engine is running.

GENERATOR SET START-UP WITH A LOW CHARGE BATTERY

The function which enables generator set start-up using a low charge battery is only enabled in automatic mode. When the voltage measured on the battery terminals drops below the min. threshold, the engine gets ignited and keeps running until the max. threshold is exceeded and the programmable delay has elapsed.

DAILY STARTING-STOPPING

The functions managed by the control unit's internal clock are only active in automatic mode. Up to 10 genset starts can be programmed, with relative switching of the power user to the generator at certain daily time slots. It is also possible to program a genset lockout at a certain daily time slot.

CALL INPUT (TERMINAL 30)

Call input is active with control unit in automatic and test modes. When the contact closes to ground, operation is the same as that of a mains failure.

START-UP INPUT (terminal 61)

The start-up input is enabled when the control unit is in automatic mode. When the contact closes, the display shows the message REMOTE START-UP. After the REMOTE START-UP DELAY time has elapsed, the machine operates as if in presence of a mains fault. As soon as the start-up contact opens, the machine starts operating as if the mains had been restored. Other functions may be associated with this input (see the Programming Manual).

STOP INPUT (terminal 60)

The stop input is enabled when the control unit is in automatic mode. When the contact closes, the display shows the message REMOTE STOP. The control unit disables all start-up operations and the generator set is stopped, if it is running. Other functions may be associated with this input (see the Programming Manual).

PROGRAMMABLE INPUTS (TERMINALS 54 and 55)

Inputs 54 and 55 are completely programmable (see the programming manual).

The following settings are possible:

Function, Text, Intervention delay, Stop, Cooling, Storage, Polarity, Activation.

ENGINE HEATING

The function takes both engine temperature and set time into account. When the engine reaches the set temperature or set time, the control unit speeds up the engine to rated speed. This default function is disabled. See the programming manual for instructions on how to set the temperature threshold and time. To do this it is necessary by activating the function in a programmable output and connecting an electromagnet to the engine.

EJP FUNCTION

To activate the EJP function, see the programming manual. It is only active in automatic mode. When the contact connected to terminal 32 closes to ground, EJP STARTUP is shown on the display. After the EJP STARTING DELAY has elapsed (set to 25 minutes), the start-up cycle begins. When the contact connected to terminal 33 closes to ground, EJP SWITCHING CONSENT is shown on the display and operation is the same as that of a mains failure. When the two contacts open, operation is the same as when mains power is restored.

GENERATOR VOLTMETRIC RELAY

The generator voltmeter relay are located inside the control unit and serve to control the mains and genset voltages and frequencies. The parameters considered are: power failure, undervoltage, overvoltage, under-frequency and overfrequency. When each parameter has been accepted individually, after the generator voltage present delay has elapsed (programmed to 7 seconds), the generator contactor closes. It takes just one parameter outside the normal range to de-energize the generator contactor.

IMMINENT START WARNING

With the exception of start-ups due to power failure or closing of a call contact, every automatic start-up is preceded by the intermittent activation of the general alarm output for 8 seconds; then, 3 seconds later, the start-up cycle begins. If a buzzer is connected to this output, the operator is notified that start-up is imminent. This function can be bypassed. Warning: the output can be associated to other functions; see the programming manual.

PASSWORD

Access to technical settings is password activated. There are 7 password levels, each level gives access to different settings. The default password settings are all "0000" and it is possible to enter the settings without entering any other codes, except for level 7. To change the codes and activate the passwords, see the programming manual. The list of the 7 levels is given below:

1. The operator can read all the settings but cannot edit them.
2. Access in editing mode to rental hours and history log from maintenance hours.
3. Access only for resetting expired maintenance.
4. Access only for resetting expired rental blocks
5. The operator can read and edit all settings.
6. Access in editing mode to total operating hours.
7. Access to the device menu.

For example: if we wish to prevent the operator from modifying the total operating hours, we must set a different password to "0000" in level 6, for example "1234". Doing this, we can enter the technical settings using the default password ("0000"), but will not have access to the operating hours. To access the operating hours menu we must enter the password "1234".

SERIAL NUMBER (ID)

It is possible to programme an alphanumeric serial code in the control unit. This number is displayed every time the control unit is switched on; it can be read in the INFORMATION menu or by pressing the left arrow for 4 seconds. Refer to the programming manual.

WIRING DIAGRAM

FOR PROTECTION OF THE ELECTRICAL EQUIPMENT AT BATTERY VOLTAGE AGAINST OVERCURRENTS, REFER TO STANDARDS IEC 44-5 (EN 60204)

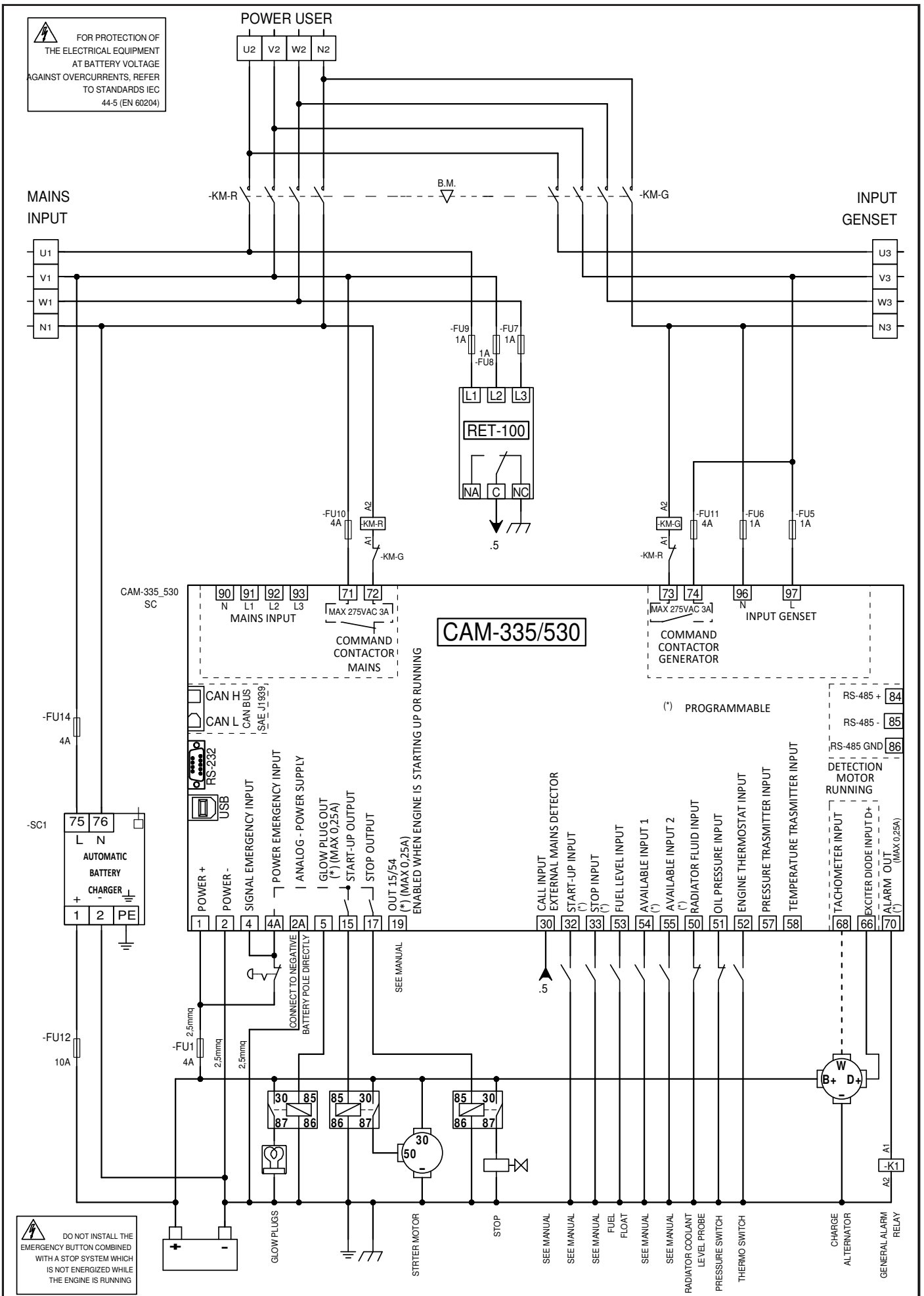

DO NOT INSTALL THE EMERGENCY BUTTON COMBINED WITH A STOP SYSTEM WHICH IS NOT ENERGIZED WHILE THE ENGINE IS RUNNING

Connection detail of the control unit with a permanent magnet battery charging alternator
Request the diagram for any other controller.

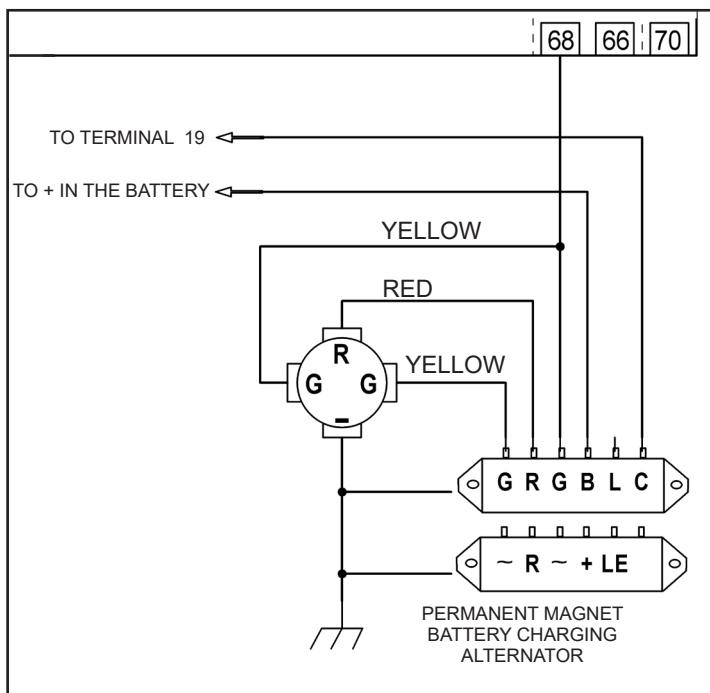

Once the connections have been made and powered, the control unit is set to OFF. See programming to change this status.

USER-PROGRAMMING



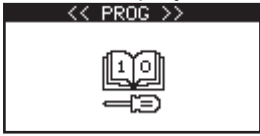

Access to the User-programmed Functions pages is gained by pressing and holding down the function button until the display shows the message "PROG".

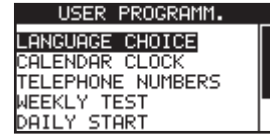

Release the button. After a few seconds the following appears:



Press the arrow keys   to scroll the programming menus. Press the key  to enter the desired sub-menu. For instance.



Press   to scroll the programming items. For instance.



Press  to confirm your selection. The display shows the following:

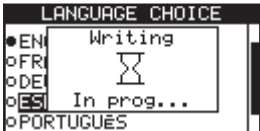

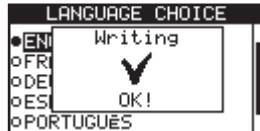

Wait a few seconds.



The chosen parameter is now programmed in the control unit. The settings are stored in a non-volatile memory, and are therefore maintained even if the power is switched off. The value can be modified at any time by repeating the procedure as described above.

Press  to return to the previous menu and then proceed to program the other parameters.

Programming a numerical parameter

When programming a numerical parameter, such as a threshold or a time, press   to increase or decrease the parameter.





Press  to confirm the value. As soon as the number is saved in the control unit, it changes colour.



Enabling/disabling a parameter.

When programming a binary parameter (enabled/disabled), for example, enabling the weekly automatic test,

press   to enable or disable the parameter. For example:

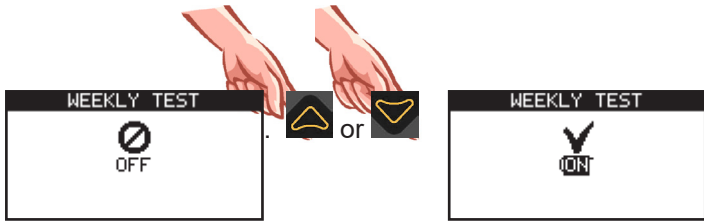

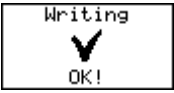
Press  to confirm the value. 

User-programmable parameters are:

Parameter	Range	Default setting	Note	
LANGUAGE CHOICE	ITALIAN	ITALIAN	A CUSTOM language cannot be selected unless the messages have been programmed with the software ZW-100-PR.	
	ENGLISH			
	FRENCH			
	GERMAN			
	SPANISH			
	PORTUGUESE			
	CUSTOM			
CLOCK/CALENDAR	Standard		Calendar clock adjustment.	
WEEKLY TEST	OFF	OFF		
	ENGAGED			
DAILY START	START 1	00:00 ÷ 23:59	--:-- ÷ --:--	With --:-- ÷ --:-- starting is off.
	START 2	00:00 ÷ 23:59	--:-- ÷ --:--	
	START 3	00:00 ÷ 23:59	--:-- ÷ --:--	
	START 4	00:00 ÷ 23:59	--:-- ÷ --:--	
	START 5	00:00 ÷ 23:59	--:-- ÷ --:--	
	START 6	00:00 ÷ 23:59	--:-- ÷ --:--	
	START 7	00:00 ÷ 23:59	--:-- ÷ --:--	
	START 8	00:00 ÷ 23:59	--:-- ÷ --:--	
	START 9	00:00 ÷ 23:59	--:-- ÷ --:--	
	START 10	00:00 ÷ 23:59	--:-- ÷ --:--	
DAILY STOP	00:00 ÷ 23:59		--:-- ÷ --:--	With --:-- ÷ --:-- stopping is off.

FAULT LIST

Find below a comprehensive list of the faults managed by the control unit.

Fault code	Description	Event causing the fault
111	MAINTENANCE 1	Maintenance 1 has expired.
112	MAINTENANCE 2	Maintenance 2 has expired.
113	MAINTENANCE 3	Maintenance 3 has expired.
114	CYCLIC MAINTENANCE	Cyclic maintenance has expired.
115	RENTAL HOURS	The rental hours have expired.
120	BATTERY UNDERVOLTAGE	The battery voltage has dropped below the programmed threshold.
121	BATTERY OVERVOLTAGE	The battery voltage has exceeded the programmed threshold.
122	LOW ENGINE TEMPERATURE	The engine has failed to reach the programmed temperature.
123	OVERTEMPERATURE ALERT	The engine has exceeded the overtemperature alert threshold.
124	OVERTEMPERATURE	The engine has exceeded the overtemperature threshold detected by the transmitter.
125	OVERTEMPERATURE FROM THERMOSTAT	The engine thermostat has tripped.
126	MAX. FUEL LEVEL	The max. fuel level contact float has tripped.
129	FUEL RESERVE	The fuel level is below the low level threshold.
130	NO FUEL	The fuel level is below the programmed threshold.
131	LOW OIL PRESSURE ALERT	The oil pressure in the engine has failed to exceed the programmed threshold.
132	LOW OIL PRESSURE	The pressure switch of the engine oil has tripped.
133	FAILURE TO STOP	The engine is still running although the stop system has been engaged.
135	LOW RADIATOR FLUID LEVEL	The level of fluid in the radiator is very low.
136	CHARGING ALTERNATOR	Output "D+" or output "W" in the charging alternator does not work.
137	FAILURE TO START	The control unit has attempted to start the genset, but the engine is not running.
139	OVERSPEED	The RPM detected by the control unit exceed the programmed threshold.
140	FUEL FLOAT CIRCUIT BROKEN	The electrical circuit in the fuel float has been broken.
141	OIL PRESSURE SWITCH FAULT	The contact of the oil pressure switch is open, but the engine is not running.
220	GENSET UNDERVOLTAGE	The genset voltage has dropped below the programmed threshold.
222	GENSET OVERVOLTAGE	The genset voltage has exceeded the programmed threshold.
223	GENSET UNDERFREQUENCY	The genset frequency (Hz) has dropped below the programmed threshold.
224	GENSET OVERFREQUENCY	The genset frequency (Hz) has exceeded the programmed threshold.
225	GENSET OVERLOAD ALERT	The current absorbed by the genset has exceeded the alert threshold.
226	GENSET OVERLOAD	The current absorbed by the genset has exceeded the alarm threshold.
227	NO POWER SUPPLY BY GENSET	Although it is running, the genset does not supply power.
228	GENSET OVERPOWER	The power absorbed by the genset has exceeded the alarm threshold.
230	GENSET PHASE SEQUENCE	The three phase sequence of the genset is not correct.
231	GENSET ASYMETRY	The three phases of the genset are not characterised by the same voltages.
323	MAINS PHASE SEQUENCE	The three phase sequence of the mains is not correct.
325	MAINS OVERLOAD	The current absorbed by the mains has exceeded the alarm threshold.
419	EMERGENCY STOP	The emergency stop button has been pressed.
421	INPUT FREE 41	The fault associated to the programmable input 41 has tripped.
422	INPUT FREE 42	The fault associated to the programmable input 42 has tripped.
426	INPUT FREE 32	The fault associated to the programmable input 32 has tripped.
427	INPUT FREE 33	The fault associated to the programmable input 33 has tripped.
430	CAN BUS	The control unit does not receive data from the CAN Bus line.
431	ENGINE CONTROL UNIT	An engine fault has been detected by the electronic control unit ECU.
443	FUEL FLOAT TABLE INCORRECT	Errors have been made during float table programming.
446	OIL PRESSURE TRANSMITTER TABLE INCORRECT	Errors have been made during oil pressure transmitter table programming.
447	TEMPERATURE TRANSMITTER TABLE INCORRECT	Errors have been made during temperature transmitter table programming.
500	NO GSM MODEM	The GSM modem does not communicate with the control unit.
501	SIM NOT INSTALLED	The SIM card has not been installed in the GSM modem.
502	SIM BLOCKED	The PIN code of the SIM card installed in the modem is not active.
503	CODED GSM ERROR	The GSM modem has detected a coded error.
504	GENERAL GSM ERROR	The GSM modem has detected a non-coded error.
505	REMOTE PANEL FAILURE TO COMMUNICATE	The remote panel does not respond to the request for data by the control unit.
506	EXP. I/O 1 FAULT	The input/output expansion module does not respond to the request for data.
507	EXP. I/O 2 FAULT	The input/output expansion module does not respond to the request for data.
508	EXP. I/O 3 FAULT	The input/output expansion module does not respond to the request for data.
509	EXP. I/O 4 FAULT	The input/output expansion module does not respond to the request for data.
510	RTCK SYBCHR.1 FAILED	RTCK synchronization of control unit 1 failed.
511	RTCK SYBCHR.2 FAILED	RTCK synchronization of control unit 2 failed.
512	RTCK SYBCHR.3 FAILED	RTCK synchronization of control unit 3 failed.
513	RTCK SYBCHR.4 FAILED	RTCK synchronization of control unit 4 failed.
556	STOP FROM GSM	The control unit has been stopped by the SMS command.
-	MDE-088 [01 – 32]	The fault associated to the programmable input of the I/O module has tripped.
-	EEPROM ERROR	Access to the static memory has not been successful.

TECHNICAL SPECIFICATIONS

Power supply			
Suitable for batteries	12 Vdc	24 Vdc	
Operating range	8 ÷ 48Vdc		
Absorption with engine not running	130mA to 12Vdc	90 mA to 24Vdc	
Voltage dip on battery power supply	From 10Vdc to 0Vdc for 250ms		
Digital inputs			
Type of input	Negative		
Maximum current supplied	0,30mA		
Voltage threshold for low signal	≤ 0,2Vdc		
Voltage threshold for high signal	≥ 2Vdc		
Terminal input 68			
AC voltage	5,5 ÷ 65Vac		
Measurement range	50 ÷ 1500Hz		
Mains and generator voltmetric inputs			
Dielectric strength voltage between battery voltage circuits and mains/generator voltage circuits	3750Vac 50Hz 1sec		
Rated insulation voltage	Mains voltage terminal	600Vac	
	Genset voltage terminal	600Vac	
	Battery voltage terminal	48Vac	
Insulation class	80 ÷ 570Vac (three-phase)	45 ÷ 340Vac (single-phase)	
Accuracy	±1%		
Frequency meter			
Measurement range	45 ÷ 85Hz		
Accuracy	±0,1Hz		
Digital outputs			
Type of output	Positive (battery voltage)		
Maximum load	Terminal 5, 15, 19, 70	0,25 A	
		1,5 A	
Contactors command outputs			
Type of output	Dry contact		
Maximum applicable voltage	275Vac		
Maximum load	3 A		
Engine instruments			
Oil pressure	0 ÷ 360Ohm	0,0 ÷ 9,0BAR	0 ÷ 900kPa
Temperature	0 ÷ 3000Ohm	0 ÷ 140°C	0 ÷ 284°F
Fuel level	0 ÷ 360Ohm	0 ÷ 100%	
Accuracy (pressure gauge, thermometer, fuel level)	±2%		
Environmental conditions			
Operating temperature	-20 ÷ 60°C		
Storage temperature	-20 ÷ 60°C		
Relative humidity	≤ 80%		
Vibration resistance	1g sui 3 axes (CEI EN 60068-2-6)		
Impact resistance	15g sui 3 axes (CEI EN 60068-2-27)		
Protection class			
Back	IP 20		
Front	IP 64		
Container			
Weight	915g		
Dimensions (LxHxW)	192x144x99mm		
Perforations	186x138mm		
Material	PC/ABS V0		

NOTICES

This control unit only monitors and controls one generator set. It commands the mains and genset contactors to power the user. It is exclusively built for recessed mounting in an electric switchboard and to be connected to other components (contactors, fuses, overload switches, etc.) that the fitter will have preliminarily set up to complete the system.



Warning: dangerous live parts!

Access to the control unit must only be granted to suitably trained staff who have been appointed to operate/service it. Maintenance operations must not be carried out when the system is connected to the mains and battery. As an additional protective measure, we recommend grounding and short-circuiting the machine phases. As an exception to the above, the interventions below are admitted on the live system, on condition that they are exclusively performed by suitably trained staff, specifically appointed for this purpose:

- visual inspection of the connections and identification marks of the control unit;
- measurement of voltage and/or current values;
- programming of functions.

These operations must in any case be carried out using equipment that ensures appropriate electrical protection.



Warning:

strictly comply with the following recommendations.

- Connect the unit following the wiring diagram given on pages 12 and 13.
- All work on the genset must be carried out with the engine stopped and with terminal 50 of the starter motor disconnected.
- Check that the consumption of the connected appliances is compatible with that described in the technical specifications.
- Install the unit so as to always allow adequate heat removal.
- Always install the unit in a position that is lower than other appliances producing or dissipating heat.
- Handle and connect the unit without mechanically stressing the electronic board.
- Do not allow pieces of copper wire or other metal residues to fall onto the control unit.
- Never disconnect the battery terminals with the engine running.
- Strictly avoid using a battery charger for emergency starting: the control unit may get damaged.
- To protect the safety of people and equipment, disconnect the terminals of the electrical system from the battery poles before connecting an external battery charger.

THIS CONTROL UNIT IS NOT SUITABLE FOR OPERATION IN THE FOLLOWING CONDITIONS:

- locations where the ambient temperature exceeds the limits specified in the technical data sheet;
- locations where variations in the air temperature and pressure are so rapid as to produce exceptional condensation;
- locations where there is a high level of pollution caused by dust, smoke, vapours, salts and corrosive or radioactive particles;
- locations where there is a high level of heat radiation from the sun, ovens or the like;
- locations where attacks from mould or small animals are possible;
- locations where there is a risk of fire or explosion;
- locations where hard knocks or vibrations can be transmitted to the control unit;
- locations where the control unit is protected by barriers or casings with a level of protection inferior to IP40.

ELECTROMAGNETIC COMPATIBILITY

This control unit operates correctly only if it is fitted in systems that comply with CE marking regulations. In fact, the unit itself complies with the immunity requirements of standard EN 61326-1, but this does not rule out malfunctioning in extreme cases that can occur in particular situations.

The fitter is responsible for verifying the absence of disturbance levels higher than those provided for by the regulations.

OPERATION AND MAINTENANCE

We recommend that the following maintenance operations be carried out weekly:

- checking for correct warning signal operation;
- checking for good battery conditions;
- checking for conductor tightness and good terminal conditions.

UNLESS WE HAVE ISSUED A WRITTEN DECLARATION TO THE CONTRARY, THIS CONTROL UNIT IS NOT SUITABLE FOR OPERATION AS A CRITICAL COMPONENT OF EQUIPMENT OR SYSTEMS AFFECTING THE LIFE OF PERSONS AND HUMAN BEINGS.

SHOULD YOUR ELECTRICAL TECHNICIAN HAVE QUESTIONS ABOUT THIS CONTROL UNIT, HE SHOULD CONTACT ONE OF OUR TECHNICIANS BY PHONE.

DATA FOR ORDERING

Type	Code
CAM-335/530	00242310