



ENAPART



93 S Railroad Avenue Unit C
Bergenfield NJ 07621 USA
www.enapart.com
sales@enapart.com



Via del Canneto 35,
Borgosatollo, Brescia - Italia
www.enapart.it
vendite@enapart.it



Barbaros Mah. Ihlamur Bul. Aĝaoĝlu
My Newwork No:3/15 Ataşehir / İstanbul
www.enapart.net
satis@enapart.net



PRIVADA 10 B SUR #3908 COL.
ANZUREZ, C.P. 72530, PUEBLA, PUE
www.enapart.com.mx
sales@enapart.com.mx



Friedrich-Ebert-Anlage 36, 60325
Frankfurt am Main, Germany
www.enapart.de
anfrage@enapart.de



4 boulevard Carnot, 95400
villiers-le-bel, Paris, France
www.enapart.fr
sales@enapart.fr



65049, ОДЕСА, ВУЛИЦЯ ІВАНА
ФРАНКА, БУДИНОК 55, ПОВЕРХ 3
www.enapart.com.ua
sales@enapart.com.ua



MUNICIPIUL BUCUREȘTI, SECTOR 3,
B-DUL BASARABIA, NR.250, CORP P+5
www.enapart.ro
sales@enapart.ro



〒584-0023 大阪府富田林市若松町
東2丁目2番16号
www.enapart.co.jp
sales@enapart.co.jp



PLAZA NUESTRA SEÑORA DE LAS
NIEVES 12 ,LOCAL ,50012,ZARAGOZA
www.enapart.es
ventas@enapart.es



Складова база „Онгъл“, Склад А2, п.к.
4006, гр. Пловдив, България
www.enapart.bg
sales@enapart.bg



3 Austin Mews, High Street, Hemel
Hempstead, HP1 3AF , United Kingdom
www.enapart.co.uk
sales@enapart.co.uk



Beverage Product Catalogue

QUICK FIND BROCHURE



FLOJET
a xylem brand

Exploded View

OVERVIEW OF PARTS

BIB backroom pumps

Flojet, a Xylem Brand provide T and G series pumps that are industry leading pumps capable of dispensing syrups, juices and wines long distances from the backroom to dispense tap.

Recirculation and carbonation pumps

Flojet, a Xylem Brand provide a range of pumps for carbonated water recirculation and water boost pumps for ambient and cold water carbonation systems.

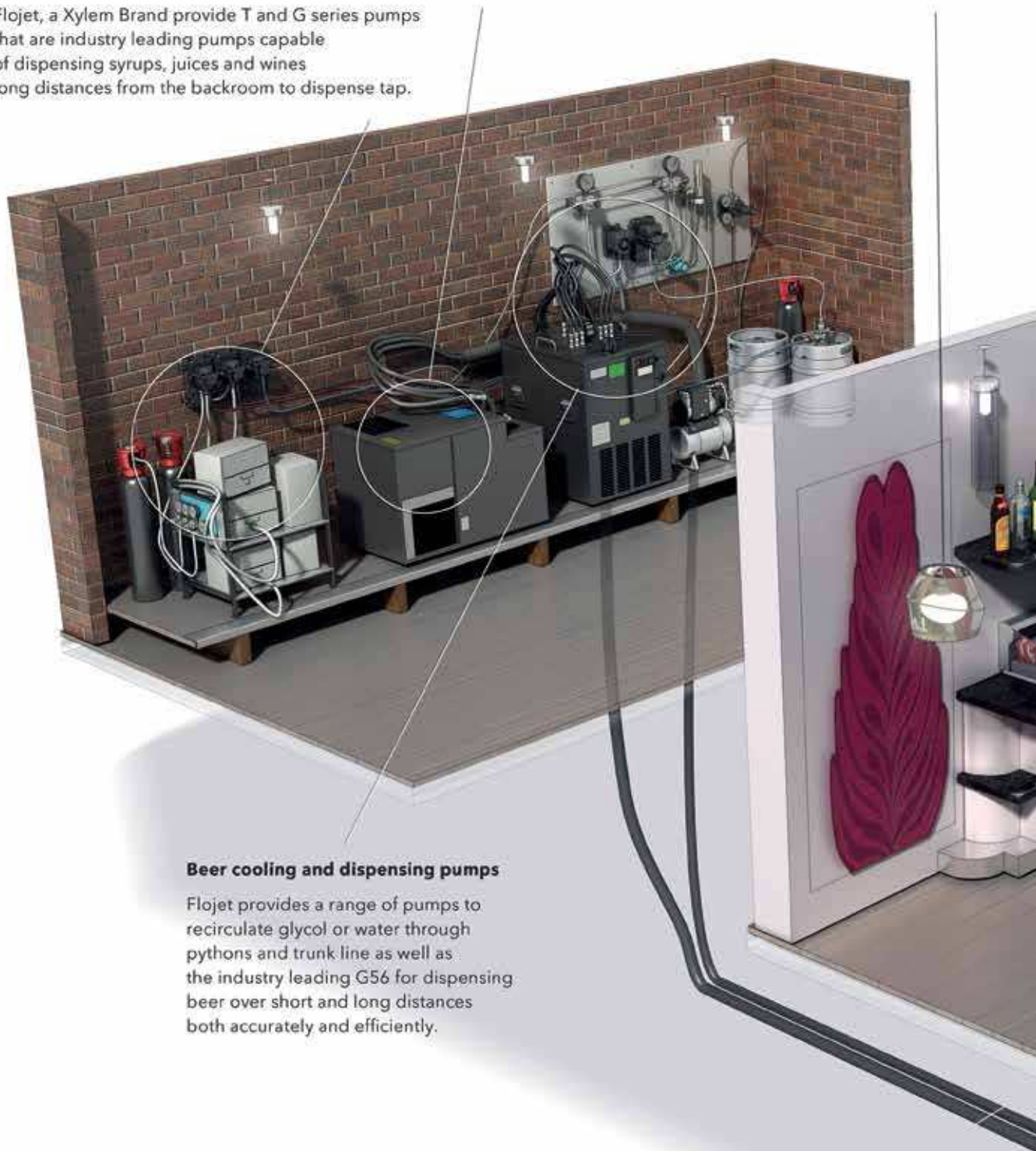

Beer cooling and dispensing pumps

Flojet provides a range of pumps to recirculate glycol or water through pythons and trunk line as well as the industry leading G56 for dispensing beer over short and long distances both accurately and efficiently.

Flash and shelf cooler pumps

Flojet has a range of pumps designed to be long lasting and efficient for recirculating cooling liquid through flash and shelf cooler systems.

Coffee and tea pumps

Flojet has developed several systems dedicated to providing water pressure to the back of coffee, espresso and tea systems, or simply to dispense water through a tap or faucet from either a bottle or to boost city water pressure.

Integral font/tap dispense pumps

Flojet has a range of electric pumps small enough and quiet enough to fit inside some fonts and taps to provide on demand dispense of BIB drinks at the bar.

BIB underbar/countertop dispense pumps

Along with the backroom BIB pumps, Flojet T and G series pumps can also be used under the bar to dispense almost anything from a BIB system.





Index

01 BEVERAGE / BEER PUMPS GAS DRIVEN	6
02 BEER / SODA CHILLING PUMPS - CENTRIFUGAL	12
03 WATER BOOST SYSTEMS	16
04 BOTTLED WATER SYSTEMS	18
05 ELECTRIC BAG-IN-BOX PUMPS	20
06 GENERAL PUMPS	22
07 BEVERAGE SOLENOID PUMPS	24
08 FILTRATION	26
09 ACCESSORIES & FITTINGS	28



01 Beverage / Beer Pumps Gas Driven

Gas (CO₂/air) driven pumps are a popular industry method for dispensing from BIBs, kegs and tanks. Flojet produces a range of gas driven pumps suitable for syrups, juices, smoothies, wine and beer.

The Flojet BeerJet series pumps are designed to dispense beer at the brewer specified keg top pressure, through long or short, vertical or horizontal beer runs. The pumps are pneumatically driven by compressed air or bottled gas. By using the BeerJet pumps, the correct equilibrium pressure is maintained on the keg keeping the carbonation level of the beer exactly as the brewer intended it to be served and enjoyed by the customer.

Air compressors can be used to pressurize the beer pumps.

The beer pump increases the pressure in the product dispense line, which ensures that the inherent gas in the solution (beer) cannot break out.

Cost effective; no need for mixed gases or gas blenders.

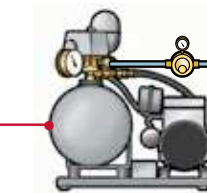

Non-pressurized
cleaning bottle CO₂ Tank

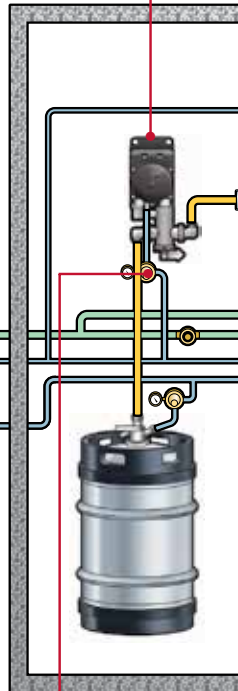

Pump can also be utilized to aid in beer line cleaning through wall mounted cleaning sockets.

Regulator valve controls the drive pressure to the pump, which provides a basis by which the pump can be infinitely variable to suit all runs and rises that are likely to be experienced with dispense lines.

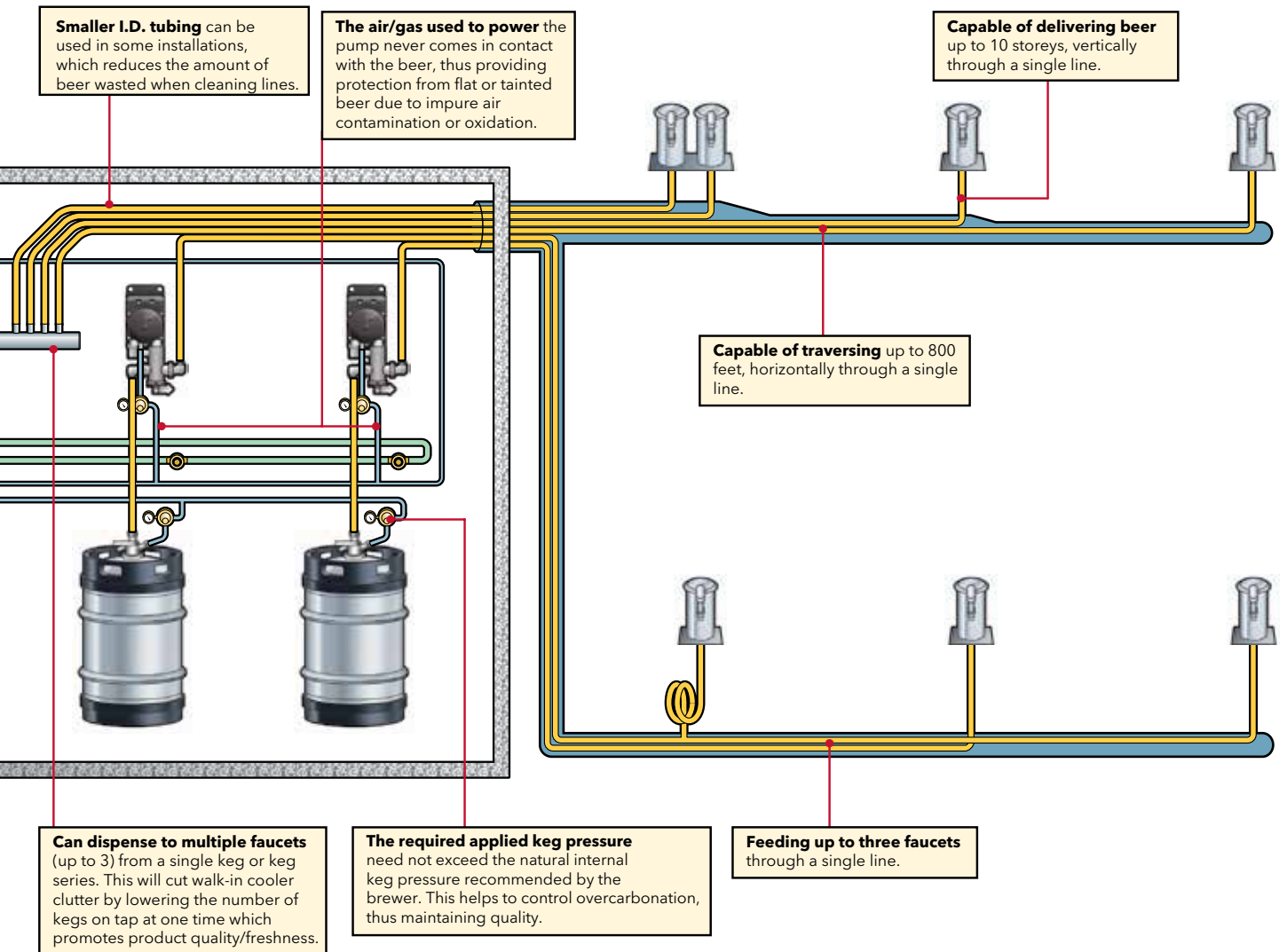

Flojet's BeerJet pumps are capable of pumping beer up to 240 meters horizontal or 30 meters vertical through a single line. The pump can dispense up to five taps from a single keg and has a service life of more than 250,000 liters.

Flojet also offers up to three taps pumps specific to syrup dispense, including the G55 which has industry leading pressure, flow and life. Flojet also produce the G80 PulpJet, specific to applications such as smoothies where particles are present





01 Beverage / Beer Pumps Gas Driven

SELECTION GUIDE

M Series	Model	Product Inlet Fitting	Product Outlet	Gas Inlet Fitting	Materials of Construction (wetted parts):
 	M50-2052	3/8" (9.52 mm) Barbed Plastic Elbow	1/4" (6.35 mm) Barbed Straight Plastic	1/4" (6.35 mm) CO ₂ Shutoff Brass	Polypropylene, TPV, Celcon, EPDM, AISI 302 Stainless Steel

T5000 Series	Model	Product Inlet Fitting	Gas Inlet Fitting	Product Outlet	Materials of Construction (wetted parts):
	T5000-130	3/8" (9.52 mm) Barbed Straight Plastic (Celcon)	3/8" (9.52 mm) Barbed Straight Plastic (Celcon)	1/4" (6.35 mm) CO ₂ Inlet Plastic (Celcon)	T5000 Polypropylene, Santoprene®, EPDM, 302 or 304 Stainless Steel Spring
	T5000-140	3/8" (9.52 mm) Barbed Straight Plastic (Celcon)	1/4" (6.35 mm) Barbed Straight Stainless Steel	1/4" (6.35 mm) CO ₂ Shutoff Brass	T5000 Polypropylene, Santoprene®, EPDM, 302 or 304 Stainless Steel Spring
	T5000-515	3/8" (9.52 mm) Barbed Straight Plastic (Celcon)	3/8" (9.52 mm) Barbed Straight Stainless Steel	1/4" (6.35 mm) CO ₂ Shutoff Brass	T5000 Polypropylene, Santoprene®, EPDM, 302 or 304 Stainless Steel Spring
	T5000-135 Service Pump (Without Auto Shutoff)	None	None	None	T5000 Polypropylene, Santoprene®, EPDM, 302 or 304 Stainless Steel Spring
	T5000-153 High Altitude Pump or installations above 3000 ft (900 M)	3/8" (9.52 mm) Barbed Straight Plastic (Celcon)	1/4" (6.35 mm) Barbed Straight Stainless Steel	1/4" (6.35 mm) CO ₂ Shutoff Brass	T5000 Polypropylene, Santoprene®, EPDM, 302 or 304 Stainless Steel Spring

T5001 Series	Model	Product Outlet Fitting	Product Inlet Fitting	CO ₂ Gas Fitting	Materials of Construction (Wetted Parts)
	T5001-130	3/8" (9.52mm) Barbed Straight Plastic	3/8"	1/4" (6.35mm) CO ₂ Shutoff Brass	Polypropylene, Santoprene®, EPDM, 302 or 304 Stainless Steel Spring
	T5001-140	1/4"	3/8"	1/4" (6.35mm) CO ₂ Shutoff Brass	Polypropylene, Santoprene®, EPDM, 302 or 304 Stainless Steel Spring

U Series	Model	Pump Design	Power Source	Materials of Construction (Wetted Parts)	Temperature Limits
 	U Series Bag-in-Box Syrup Pump	Positive Displacement, double diaphragm	CO ₂ Gas, Nitrogen or Compressed Dry Filtered Air	Polypropylene, E.U. Food Contact & NSF Elastomer, EPDM, AISI 303 or 304 Stainless Steel	34° - 120°F (1.1° - 49°C)

Dimensions: (Height x Width x Depth)	Displacement:	Self Priming:	Operating Pressure:	Liquid Inlet Pressure:	Flow Rate:	Approvals:	Warranty:
5.93" H x 2.8" W x 3.62" D (150.6mm x 71.1mm x 91.9mm)	0.5 oz (14.8cc) per cycle	Up to 6ft (1.83 m)	20 psi (1.4 bar) min / 70 psi (4.8 bar) max	0 psi max	2 oz (59.1 ml) / sec - Open Flow (Water) @ 70 psi (4.8 bar)	NSF listed, CE EU Food Directive 1935/2004/ EC	3 years

Dimensions: (Height x Width x Depth)	Displacement:	Self Priming:	Operating Pressure:	Liquid Inlet Pressure:	Flow Rate:	Approvals:	Warranty:
5.17" x 6.18" x 2.42" (131.3 mm x 156.8 mm x 61.5 mm)	2.5 oz. per cycle	Up to 10 ft. (3.05 m)	20 psi (1.4 bar) min. / 80 psi (5.5 bar) max.	10 psi (0.7 bar) max.	4.0 oz. (118.3 ml)/ sec. - Open Flow	CE, NSF Standard 18	5 Years
5.17" x 6.18" x 2.42" (131.3 mm x 156.8 mm x 61.5 mm)	2.5 oz. per cycle	Up to 10 ft. (3.05 m)	20 psi (1.4 bar) min. / 80 psi (5.5 bar) max.	10 psi (0.7 bar) max.	4.0 oz. (118.3 ml)/ sec. - Open Flow	CE, NSF Standard 18	5 Years
5.17" x 6.18" x 2.42" (131.3 mm x 156.8 mm x 61.5 mm)	2.5 oz. per cycle	Up to 10 ft. (3.05 m)	20 psi (1.4 bar) min. / 80 psi (5.5 bar) max.	10 psi (0.7 bar) max.	4.0 oz. (118.3 ml)/ sec. - Open Flow	CE, NSF Standard 18	5 Years
5.17" x 6.18" x 2.42" (131.3 mm x 156.8 mm x 61.5 mm)	2.5 oz. per cycle	Up to 10 ft. (3.05 m)	20 psi (1.4 bar) min. / 80 psi (5.5 bar) max.	10 psi (0.7 bar) max.	4.0 oz. (118.3 ml)/ sec. - Open Flow	CE, NSF Standard 18	5 Years
5.17" x 6.18" x 2.42" (131.3 mm x 156.8 mm x 61.5 mm)	2.5 oz. per cycle	Up to 10 ft. (3.05 m)	20 psi (1.4 bar) min. / 80 psi (5.5 bar) max.	10 psi (0.7 bar) max.	4.0 oz. (118.3 ml)/ sec. - Open Flow	CE, NSF Standard 18	5 Years

Dimensions	Displacement:	Self Priming	Operating Pressure	Flow Rate	Approvals	Warranty
5.26" H x 6.18" W x 2.89" D (133.6mm x 156.8mm x 73.5mm)	2.5oz per cycle	Up to 10ft (3.05m)	20 psi (1.4 bar) min / 80 psi (5.5 bar) max	4.0oz (118.3ml)/ sec - Open Flow	CE, NSF Standard 18, EU Food Directive 1935/2004/EC	5 Years
5.26" H x 6.18" W x 2.89" D (133.6mm x 156.8mm x 73.5mm)	2.5oz per cycle	Up to 10ft (3.05m)	20 psi (1.4 bar) min / 80 psi (5.5 bar) max	4.0oz (118.3ml)/ sec - Open Flow	CE, NSF Standard 18, EU Food Directive 1935/2004/EC	5 Years

Weight	Dimensions	Displacement	Self Priming	Operating Pressure	Liquid Inlet Pressure	Flow Rate	Noise Level	Approvals
1.6lbs (0.73kg)	6.75" H x 4.00" W x 5.50" D	2.2 oz (65.1 ml) per cycle	Up to 10ft (3.05m)	20 psi (1.4 bar) min / 90 psi	5 psi (0.34 bar) max	4.3 oz (127.2 ml) / sec - Open Flow	Maximum 80 dB	NSF listed & CE EU Food Directive

01 Beverage / Beer Pumps Gas Driven

SELECTION GUIDE

G55 Series



Model	Product Inlet Fitting	Gas Inlet Fitting	Product Outlet	Materials of Construction (wetted parts):
G55-1022	3/8" (9.52 mm) Barbed Straight Stainless Steel	3/8" (9.52 mm) Barbed Straight Stainless Steel	1/4" (6.35 mm) CO ₂ Shutoff Brass	Polypropylene, Santoprene®, EPDM, AISI 303 & 304 Stainless Steel
G55-1012	3/8" (9.52 mm) Barbed Straight Stainless Steel	1/4" (6.35 mm) Barbed Straight Stainless Steel	1/4" (6.35 mm) CO ₂ Shutoff Brass	Polypropylene, Santoprene®, EPDM, AISI 303 & 304 Stainless Steel

G58 Series



Model	Product Inlet Fitting	Gas Inlet Fitting	Product Outlet	Materials of Construction (wetted parts):
G58-1022	3/8" (9.52 mm) Barbed Straight Stainless Steel	3/8" (9.52 mm) Barbed Straight Stainless Steel	1/4" (6.35 mm) CO ₂ Shutoff Brass	Polypropylene, Santoprene®, EPDM, AISI 303 & 304 Stainless Steel

G56 BeerJet



Model	Product Inlet Fitting	Gas Inlet Fitting	Product Outlet	Materials of Construction (wetted parts):
G56-1202	10 - 13 mm (3/8"-1/2") Barbed Straight Plastic (Polypropylene)	10 - 13 mm (3/8"-1/2") Barbed Straight Plastic (Polypropylene)	1/4" (6.35 mm) CO ₂ Shutoff Brass	Polypropylene, Santoprene®, EPDM, AISI 304 Stainless Steel
G56-1162	10 - 13 mm (3/8"-1/2") Barbed Straight Plastic	10 - 13 mm (3/8"-1/2") Barbed Elbow Plastic	1/4" (6.35 mm) CO ₂ Shutoff Brass	Polypropylene, Santoprene®, EPDM, AISI 304 Stainless Steel

G80 PulpJet



Model	Product Inlet Fitting	Gas Inlet Fitting	Product Outlet	Materials of Construction (wetted parts):
G80-1022	3/8" (9.52 mm) Barbed Straight Stainless Steel	3/8" (9.52 mm) Barbed Straight Stainless Steel	1/4" (6.35 mm) CO ₂ Shutoff Brass	Polypropylene, Santoprene®, EPDM, AISI 303 & 304 Stainless Steel

Dimensions: (Height x Width x Depth)	Displacement:	Self Priming:	Operating Pressure:	Liquid Inlet Pressure:	Flow Rate:	Approvals:	Warranty:
5.27" x 3.21" x 4.58" (133.8 mm x 81.5 mm x 116.3 mm)	3.2 oz. per cycle	Up to 10 ft. (3.05 m)	20 psi (1.4 bar) min. / 90 psi (6.2 bar) max.	30 psi (2.1 bar) max.	7.0 oz. (207.0 ml)/ sec. - Open Flow	CE, SK, NSF Standard 18	5 Years
5.27" x 3.21" x 4.58" (133.8 mm x 81.5 mm x 116.3 mm)	3.2 oz. per cycle	Up to 10 ft. (3.05 m)	20 psi (1.4 bar) min. / 90 psi (6.2 bar) max.	30 psi (2.1 bar) max.	7.0 oz. (207.0 ml)/ sec. - Open Flow	CE, SK, NSF Standard 18	5 Years

Dimensions: (Height x Width x Depth)	Displacement:	Self Priming:	Operating Pressure:	Liquid Inlet Pressure:	Flow Rate:	Approvals:	Warranty:
5.27" x 3.21" x 4.58" (133.8 mm x 81.5 mm x 116.3 mm)	3.2 oz. per cycle	Up to 6 ft. (1.83 m)	20 psi (1.4 bar) min. / 90 psi (6.2 bar) max.	30 psi (2.1 bar) max.	6.0 oz. (177.4 ml) /sec. - Open Flow	CE, NSF Standard 18	3 Years

Dimensions: (Height x Width x Depth)	Displacement:	Self Priming:	Operating Pressure:	Liquid Inlet Pressure:	Flow Rate:	Approvals:	Warranty:
5.27" x 3.21" x 4.58" (133.8 mm x 81.5 mm x 116.3 mm)	3.2 oz. (91 ml) per cycle	Up to 10 ft. (3.05 m)	10 psi (0.7 bar) min. / 90 psi (6.2 bar) max.	30 psi (2.1 bar) max.	5 GPM (18.9 LPM) - Open Flow	CE, SK, NSF Standard 18	Up to 5 years
5.27" x 3.21" x 4.58" (133.8 mm x 81.5 mm x 116.3 mm)	3.2 oz. (91 ml) per cycle	Up to 10 ft. (3.05 m)	10 psi (0.7 bar) min. / 90 psi (6.2 bar) max.	30 psi (2.1 bar) max.	5 GPM (18.9 LPM) - Open Flow	CE, SK, NSF Standard 18	Up to 5 years

Dimensions: (Height x Width x Depth)	Displacement:	Self Priming:	Operating Pressure:	Liquid Inlet Pressure:	Flow Rate:	Approvals:	Warranty:
5.27" x 3.21" x 4.58" (133.8 mm x 81.5 mm x 116.3 mm)	3.2 oz. per cycle	Up to 6 ft. (1.83 m)	20 psi (1.4 bar) min. / 80 psi (5.5 bar) max.	30 psi (2.1 bar) max.	6.0 oz. (177.4 ml)/ sec. - Open Flow	NSF listed, CE	3 years

02 Beer / Soda Chilling Pumps - Centrifugal



HPR Series	Model	Voltage	Port Details
	HPR 6/8	230V 1Ph 50/60Hz	½" (12.5mm) or 15mm OD 3/8" OD Push Fit
	HPR 6/8	110V 1Ph 50/60Hz	½" (12.5mm) or 15mm OD 3/8" OD Push Fit
	HPR 6/11	230V 1Ph 50/60Hz	½" (12.5mm) or 15mm OD 3/8" OD Push Fit
	HPR 6/11	110V 1Ph 50/60Hz	½" (12.5mm) or 15mm OD 3/8" OD Push Fit
	HPR & GPR 10/15	230V 1Ph 50/60Hz	½" (12.5mm) or 15mm OD
	HPR & GPR 10/15	110V 1Ph 50/60Hz	½" (12.5mm) or 15mm OD

VM Series	Model	Voltage	Port Details
	VM8/2	230V 1Ph 50Hz	Plain 13mm or ¼" bsp Male
	VM12/2	110V or 230V 1Ph 50/60Hz	Plain 13mm or ¼" bsp Male
	VM25/2	110V or 230V 1Ph 50/60Hz	Plain 21mm or ½" bsp Male
	VM35/3	110V or 230V 1Ph 50/60Hz	Plain 21mm or ½" bsp Male

GP Series	Model	Voltage	Port Details
	GP20/12	230V 1Ph 50Hz	Plain 15 mm, 3/8" npt, 3/8" bsp Male
	GP20/12	110V 1Ph 50Hz	Plain 15 mm, 3/8" npt, 3/8" bsp Male
	GP20/18	110V 1Ph 50Hz	Plain 15 mm, 3/8" npt, 3/8" bsp Male
	GP20/18	230V 1Ph 50Hz	Plain 15 mm, 3/8" npt, 3/8" bsp Male
	GP20/22	230V 1Ph 50Hz	Plain 15 mm, 3/8" npt, 3/8" bsp Male

GP28/11 Series	Model	Voltage	Port Details
	GP28/11	230V 1Ph 50Hz	Plain 15 mm
	GP28/11	230V 1Ph 60Hz	Plain 15 mm

GP50/25 Series	Model	Voltage	Port Details
	GP50/25	230V 1Ph 50Hz	Plain 1.1 in (28 mm)
	GP50/25	415V 3Ph 50Hz	Plain 1.1 in (28 mm)

SELECTION GUIDE

Dimensions: (height x width x depth)	Weight:	Fluid Temperature	Max Body Pressure:	Flow Rate: (l/min)	Pump Design:	Materials of Construction (wetted parts):	Approvals:
3.86" x 6.95" x 4.45" (98 mm x 176.5 mm x 113 mm)	5.51 lb (2.5 kg)	-4°F to +185°F (-20°C to +85°C)	145 psi (10 bar) max	5.5 LPM - Open Flow	Magnetically Coupled Regenerative Pump	PPS, LCP, EPDM & Ceramic	CE, UL
3.86" x 6.95" x 4.45" (98 mm x 176.5 mm x 113 mm)	5.51 lb (2.5 kg)	-4°F to +185°F (-20°C to +85°C)	145 psi (10 bar) max	5.5 LPM- Open Flow	Magnetically Coupled Regenerative Pump	PPS, LCP, EPDM & Ceramic	CE, UL
5.63" x 7.80" x 4.02" (143 mm x 198 mm x 102 mm)	6.17 lb (2.8 kg)	-4°F to +185°F (-20°C to +85°C)	145 psi (10 bar) max	5.5 LPM - Open Flow	Magnetically Coupled Regenerative Pump	PPS, LCP, EPDM & Ceramic	CE, UL
5.63" x 7.80" x 4.02" (143 mm x 198 mm x 102 mm)	6.17 lb (2.8 kg)	-4°F to +185°F (-20°C to +85°C)	145 psi (10 bar) max	5.5 LPM- Open Flow	Magnetically Coupled Regenerative Pump	PPS, LCP, EPDM & Ceramic	CE, UL
5.63" x 7.60" x 4.21" (143 mm x 193 mm x 107 mm)	6.83 lb (3.1 kg)	-4°F to +185°F (-20°C to +85°C)	145 psi (10 bar) max	10 LPM- Open Flow	Magnetically Coupled Regenerative Pump	PPS, LCP, EPDM & Ceramic	CE, UL
5.63" x 7.60" x 4.21" (143 mm x 193 mm x 107 mm)	6.83 lb (3.1 kg)	-4°F to +185°F (-20°C to +85°C)	145 psi (10 bar) max	10 LPM- Open Flow	Magnetically Coupled Regenerative Pump	PPS, LCP, EPDM & Ceramic	CE, UL

Dimensions: (height x width x depth)	Weight:	Fluid Temperature	Max Body Pressure:	Flow Rate:	Pump Design:	Materials of Construction (wetted parts):	Approvals:
3.62" x 4.72" x 2.87" (92 mm x 120 mm x 73 mm)	5.51 lb (2.5 kg)	-4°F to +185°F (-20°C to +85°C)	20.3 psi (1.4 bar) max	5.5 GPM (20.8 LPM) - Open Flow	Magnetically Coupled Centrifugal Pump	Polypropylene, Nitrile or Silicone	CE/NSF
3.62" x 4.72" x 2.87" (92 mm x 120 mm x 73 mm)	5.51 lb (2.5 kg)	-4°F to +185°F (-20°C to +85°C)	20.3 psi (1.4 bar) max	5.5 GPM (20.8 LPM) - Open Flow	Magnetically Coupled Centrifugal Pump	Polypropylene, Nitrile or Silicone	CE/NSF
3.62" x 4.72" x 2.87" (92 mm x 120 mm x 73 mm)	5.51 lb (2.5 kg)	-4°F to +185°F (-20°C to +85°C)	20.3 psi (1.4 bar) max	5.5 GPM (20.8 LPM) - Open Flow	Magnetically Coupled Centrifugal Pump	Polypropylene, Nitrile or Silicone	CE/NSF
3.62" x 4.72" x 2.87" (92 mm x 120 mm x 73 mm)	5.51 lb (2.5 kg)	-4°F to +185°F (-20°C to +85°C)	20.3 psi (1.4 bar) max	5.5 GPM (20.8 LPM) - Open Flow	Magnetically Coupled Centrifugal Pump	Polypropylene, Nitrile or Silicone	CE/NSF







Dimensions: (height x width x depth)	Weight:	Temp Range	Max Body Pressure:	Run-out Flow Rate:	Motor Output:	Closed Valve head:	Max Specific Gravity*
5.6" x 8.6" x 4.6" (143 mm x 218 mm x 116 mm)	6.6 lb (3.0 kg)	-4°F to +185°F (-20° C to +85° C)	36.3 psi (2.5 bar)	4.6 GPM (17.4 LPM)	60 watts	41.6' (12.7 m)	1.2
5.6" x 8.6" x 4.6" (143 mm x 218 mm x 116 mm)	6.6 lb (3.0 kg)	-4°F to +185°F (-20° C to +85° C)	36.3 psi (2.5 bar)	4.6 GPM (17.4 LPM)	60 watts	41.6' (12.7 m)	1.2
5.6" x 10.1" x 4.6" (143 mm x 259 mm x 116 mm)	8.5 lb (3.9 kg)	-4°F to +185°F (-20° C to +85° C)	36.3 psi (2.5 bar)	4.8 GPM (18.5 LPM)	90 watts	59.0' (18 m)	1.2
5.6" x 10.1" x 4.6" (143 mm x 259 mm x 116 mm)	8.5 lb (3.9 kg)	-4°F to +185°F (-20° C to +85° C)	36.3 psi (2.5 bar)	4.8 GPM (18.5 LPM)	90 watts	59.0' (18 m)	1.2
5.6" x 11.0" x 4.6" (143 mm x 280 mm x 116 mm)	8.8 lb (4.0 kg)	-4°F to +185°F (-20° C to +85° C)	36.3 psi (2.5 bar)	4.6 GPM (17.5 LPM)	-	72.2' (22 m)	1.2

Dimensions: (height x width x depth)	Weight:	Temp Range (C)	Max Body Pressure:	Run-out Flow Rate:	Motor Output:	Closed Valve head:	Max Specific Gravity*
6.2" x 10.4" x 5.2" (158 mm x 264 mm x 132 mm)	7.1lb (3.2 kg)	-4°F to +185°F (-20° C to +85° C)	20.3 psi (1.4 bar)	7.6 GPM (29 LPM)	60 watts	36.1 ft (11 m)	1
6.2" x 10.4" x 5.2" (158 mm x 264 mm x 132 mm)	7.1lb (3.2 kg)	-4°F to +185°F (-20° C to +85° C)	20.3 psi (1.4 bar)	7.6 GPM (29 LPM)	60 watts	36.1 ft (11 m)	1

Dimensions: (height x length x width)	Weight:	Operating Pressure:	Flow Rate:	Closed Valve head	Pump Design:	Motor Output:	Approvals:
8.1" x 17.4" x 6.3" (206 mm x 443 mm x 159 mm)	22.3 lb (10.1 kg)	30 PSI (2.1 bar) (2.0 bar) max.	16.25 GPM (61.5 LPM) - Open Flow	31.5 m	Magnetically Coupled Centrifugal Pump	550 watts	CE
8.1" x 17.4" x 6.3" (206 mm x 443 mm x 159 mm)	22.3 lb (10.1 kg)	30 PSI (2.1 bar) (2.0 bar) max.	16.25 GPM (61.5 LPM) - Open Flow	31.5 m	Magnetically Coupled Centrifugal Pump	550 watts	CE

02 Beer / Soda Chilling Pumps - Centrifugal

SELECTION GUIDE

SPC8/2 Series	Model	Voltage	Port Details	Dimensions: (height x length)	Weight:	Fluid Temperature	Operating Pressure:
	SPC 8/2	110 or 230V 50/60Hz	Plain 13mm or ½" BSP male	6.85" x 8.82" (174 mm x 224 mm)	2.2 lb (1 kg)	-4° to +185° F (-20° to +85° C)	0.2 bar (3 psi)max.
SPC12/4 Series	Model	Voltage	Port Details	Dimensions: (height x length x width)	Weight:	Fluid Temperature	Operating Pressure:
	SPC 12/4	110 or 230V 50/60Hz	Plain 0.51 (13 mm)	3.1" x 8.5" x 4.3" (80.3 mm x 216.3 mm x 109 mm)	3.0 lb (1.4kg)	-4° to +185° F (-20° to +85° C)	5.3 psi (0.4 bar) max.
SPC51 Series	Model	Voltage	Port Details	Dimensions: (height x length)	Weight:	Fluid Temperature	Operating Pressure:
	SPC 51	110V or 230V 50/60Hz	½" (12.5mm) and 11mm	5.27" x 3.21" (107 mm x 289 mm)	4.4 lb (2 kg)	-4° to +185° F (-20° to +85° C)	50 Hz - 9.6 psi (0.6 bar) max., 60 Hz - 11.5 psi (0.8 bar) max.
SPC42 Series	Model	Voltage	Port Details	Dimensions: (height x length)	Weight:	Fluid Temperature	Operating Pressure:
	SPC 42	110 or 230V 50/60Hz	½" (12.5mm) and 11mm	4.61" x 12.56" (117 mm x 319 mm)	5.5 lb (2.5 kg)	-4° to +185° F (-20° to +85° C)	50 Hz - 18 psi (1.2 bar) max., 60 Hz - 23 psi (1.5 bar) max.
SPC43 Series	Model	Voltage	Port Details	Dimensions: (height x length)	Weight:	Fluid Temperature	Operating Pressure:
	SPC 43	110 or 230V 50/60Hz	½" (12.5mm) and 11mm	5.39" x 14.17" (137 mm x 360 mm)	7.0 lb (3.2 kg)	-4° to +185° F (-20° to +85° C)	50 Hz - 27 psi (1.8 bar) max. 60 Hz - 36 psi (2.4bar) max.
SPC44 Series	Model	Voltage	Port Details	Dimensions: (height x length)	Weight:	Fluid Temperature	Operating Pressure:
	SPC 44	110 or 230V 50/60Hz	½" (12.5mm) and 11mm	5.39" x 14.7" (137 mm x 360 mm)	7.50 lb (3.4 kg)	-4° to +185° F (-20° to +85° C)	50Hz - 33 psi (2.2 bar)
SPC18 Series	Model	Voltage	Port Details	Dimensions: (height x length)	Weight:	Fluid Temperature	Operating Pressure:
	SPC 18	230V 50/60Hz	½" (12.5mm) and 11mm	5.76" x 14.9" (146.5 mm x 378.5 mm)	8.2 lb (3.7kg)	-4° - 185° F (-20° - 85° C)	27psi (1.8bar)max.

Flow Rate:	Pump Design:	Motor Output	Approvals:
50Hz- 2.25 GPM (8.5 LPM) or 60Hz - 2.06 GPM (7.8 LPM)- run out	Semi-Submersible Column Pump 1 Stage	10 watts	CE, UL
Flow Rate:	Pump Design:	Motor Output	Approvals:
3.4 GPM (13 LPM) - Open Flow	Semi-Submersible Column Pump 1 Stage	18 watts	CE, UL
Flow Rate:	Pump Design:	Motor Output	Approvals:
50HZ - 4.25 GPM (16.1 LPM) or 50HZ - 4 GPM (15.3)	Semi-Submersible Column Pump 1 Stage	30 watts	CE, UL
Flow Rate:	Pump Design:	Motor Output	Approvals:
50Hz - 3.75 GPM (14.2 LPM) or 60Hz - 4.12 GPM (15.6LPM)- Open Flow	Semi-Submersible Column Pump 2 Stage	60 watts	CE, UL
Flow Rate:	Pump Design:	Motor Output	Approvals:
50Hz - 4.25 GPM (16.1 LPM) or 60Hz - 4.57 GPM (17.3 LPM)- Open Flow	Semi-Submersible Column Pump 3 Stage	90 watts	CE, UL
Flow Rate:	Pump Design:	Motor Output	Approvals:
4.23 GPM (16 LPM) - Open Flow	Semi-Submersible Column Pump 4 Stage	90 watts	CE, UL
Flow Rate:	Pump Design:	Motor Output	Approvals:
50Hz- 4.8 GPM (18 LPM) - Run out Flow	Semi-Submersible Column Pump 3 Stage	90 watts	CE, UL

03 Water Booster Systems

G60 Series	Model	Product Inlet Fitting	Pump Design:	Gas Inlet Fitting	Weight
	G60-1215	½" (9.52 mm) Barbed Straight Plastic (Polypropylene)	Positive Displacement, Double Diaphragm	½" (9.52 mm) Barbed Straight Plastic (Polypropylene)	1.24 lb (0.56 kg)

K56 Series	Model	Product Inlet Fitting	Pump Design:	Gas Inlet Fitting	Weight
	K56-1030	½" (12.7 mm) Barbed Straight Plastic (Polypropylene)	Positive Displacement, Double Diaphragm	½" (12.7 mm) Barbed Straight Nylon	1.24 lb (0.56 kg)

Port Fittings: **Gas Inlet & Outlet** ¼" (6.3 mm) Barbed,
Pump Product Inlet ½" (12.7 mm) Barbed, **Tank Product Outlet** ½" (12.7 mm) Barbed

2830 Series	Part Number	Description	Amp Draw:
	R28302512	230VAC, 87 psi (6 bar), 1.5 gpm (5.7 lpm)	0,5
	R28304512	230VAC, 87 psi (6 bar), 1.5 gpm (5.7 lpm)	0,5
	028300512	115VAC, 87 psi (6 bar), 1.5 gpm (5.7 lpm)	0,9
	R28304542	230VAC, 87 psi (6 bar), 1.5 gpm (5.7 lpm)	0,5
	R28303542	230VAC, 87 psi (6 bar), 1.5 gpm (5.7 lpm)	0,5
	R28302542	230VAC, 87 psi (6 bar), 1.5 gpm (5.7 lpm)	0,5
	028300542	115VAC, 87 psi (6 bar), 1.5 gpm (5.7 lpm)	0,9
	028300543	115VAC, 87 psi (6 bar), 1.5 gpm (5.7 lpm)	0,9

2840 Series	Part Number	Description
	2840-010	115 V AC, 40 PSI (2.7 bar) switch, 35 GPM (13.2 LPM)
	2840-000	115 V AC, 40 PSI (2.7 bar) switch, 4.5 GPM (17 LPM)
	2840-210	230 V AC, 40 PSI (2.7 bar) switch, 3.5 GPM (13.2 LPM)
	2840-100	12V DC, 45 PSI (3.1 bar) switch, 4.5 GPM (17 LPM)

Water Booster Accessories	Part Number	Description
	01752300C	50 PSI (3.4 bar), QD CONNECT, NO PORTS
	01752302C	50 PSI (3.4 bar), QD CONNECT, ³⁄₈" (9.5 mm) HB PORTS
	01752320C	30 PSI (2.1 bar) (2.0 bar), QD CONNECT, NO PORTS
	01752322C	30 PSI (2.1 bar) (2.0 bar), QD CONNECT ³⁄₈" (9.5 mm) HB PORTS

Pressurized Accumulator Tank	Part Number	Description
	30573-001	0.26 gallon (1 liter) accumulator tank

SELECTION GUIDE

Product Outlet	Power Source	Materials of Construction (wetted parts):	Temperature Limits	Dimensions: (Height x Width x Depth)	Displacement:	Self Priming:	Operating Pressure:	Liquid Inlet Pressure:	Flow Rate:	Approvals:
¼" (6.35 mm) CO ₂ Shutoff Brass	CO ₂ Gas, Nitrogen or Compressed Dry Filtered Air	Polypropylene, Santoprene®, EPDM, AISI 303 & 304 Stainless Steel	34° to 120° F (1.1° to 49° C)	5.27" x 3.21" x 4.58" (133.8 mm x 81.5 mm x 116.3 mm)	3.2 oz. (91 ml) per cycle	Up to 10 ft. (3.05 m)	20 psi (1.4 bar) min. / 90 psi (6.2 bar) max.	30 PSI (2.1 bar) (2.1 bar) max.	5 GPM (18.9 LPM) - Open Flow	CE, SK, NSF Standard 18

Product Outlet	Power Source	Materials of Construction (wetted parts):	Temperature Limits	Dimensions: (Height x Width x Depth)	Displacement:	Self Priming:	Operating Pressure:	Bladder Tank	Liquid Inlet Pressure:	Flow Rate:
¼" (6.35 mm) CO ₂ Shutoff Brass	CO ₂ Gas, Nitrogen or Compressed Dry Filtered Air	Polypropylene, Santoprene®, EPDM, AISI 303 & 304 Stainless Steel, Brass	34° to 120° F (1.1° to 49° C)	12" x 11.5" x 7" (304.8 mm x 292.1 mm x 177.8 mm)	3.2 oz. (91 ml) per cycle	Up to 10 ft. (3.05 m)	60 psi (4.1 bar) min. / 90 psi (6.2 bar) max.	Precharged to 20 PSI (1.4 bar)	30 psi (2.1 bar) max.	5 GPM (18.9 LPM) - Open Flow

Warranty	Inlet Size	Outlet Size	Tank Size	Plug Type
1 Year	3/8" HB	3/8" HB	1 US Gal / 3.78 Litre)	EU 2 pin
1 Year	3/8" HB	3/8" HB	1 US Gal / 3.78 Litre)	UK 3 pin
1 Year	3/8" HB	3/8" HB	1 US Gal / 3.78 Litre)	US 2 pin
1 Year	3/8" HB	3/8" HB	4US Gal / 15 litre	UK 3 pin
1 Year	3/8" HB	3/8" HB	4US Gal / 15 litre	Australia 2 pin
1 Year	3/8" HB	3/8" HB	4US Gal / 15 litre	EU 2 pin
1 Year	3/8" HB	3/8" HB	4US Gal / 15 litre	US 2 pin
1 Year	3/8" HB	1/2" HB	4US Gal / 15 litre	US 2 pin

Amp Draw:	Motor:	Warranty:	Inlet and Outlet Ports:
115 Volt AC: 1.5 amps max., 230 Volt AC: 0.75 amps max.	Permanent Magnet TENV	1 Year	½" (13 mm) OD or 3/4" (19 mm) OD hose barb
115 Volt AC: 1.5 amps max., 230 Volt AC: 0.75 amps max.	Permanent Magnet TENV	1 Year	½" (13 mm) OD or 3/4" (19 mm) OD hose barb
115 Volt AC: 1.5 amps max., 230 Volt AC: 0.75 amps max.	Permanent Magnet TENV	1 Year	½" (13 mm) OD or 3/4" (19 mm) OD hose barb
115 Volt AC: 1.5 amps max., 230 Volt AC: 0.75 amps max.	Permanent Magnet TENV	1 Year	½" (13 mm) OD or 3/4" (19 mm) OD hose barb

Pressurized Mini Accumulator Tank

Part Number Description

- 30573-0002B 0.1 gallon (½ liter) accumulator tank (rubber valve)
- 30573-0012B 1 gallon (½ liter) accumulator tank (metal valve)



Pressurized Large Accumulator Tank

Part Number Description

- 18810-0000 1 gallon (3.8 liter) accumulator tank
- 20799-000A 0.60 gallon (2.27 liter) accumulator tank



04 Bottled Water Systems



BW5000 Series



APPLICATIONS

- ↳ Designed for dispensing bottled water to coffee machines, beverage dispensers, vending machines and carts.
- ↳ For remote locations where water supply is inaccessible

FEATURES AND BENEFITS

- ↳ Illuminated On/Off Switch: Provides clear visibility in dark or hard-to-reach places
- ↳ Long-Life Motor: Ensures years of reliable operation
- ↳ Flojet Diaphragm Pump: Runs dry without damage, extending pump life
- ↳ Quick Connect Port: Speeds installation and replacement of suction and discharge tubing
- ↳ Quiet Operation: Minimizes noise pollution with noise-dampening rubber feet
- ↳ Thermal Overload Protection: Prevents overheating, protecting the pump and control box from damage

KITS

- ↳ Dual inlet suction kits (convert single inlet to dual inlet) PN# 21000633A
- ↳ Single inlet suction hose replacement kit PN# 21000006B
- ↳ Dual inlet suction kits (convert single inlet to dual inlet) PN# 21000633A
- ↳ Auxiliary suction tube (no float) replacement kit PN# 21000596C

STANDARD MODEL NUMBERS

MODEL #	VAC	PLUG
SINGLE INLET		
BW5000-000A	115 VAC	US Plug
BW5001-000A	100-240 VAC	No Plug
BW5002-000A	230 VAC	AUS Plug
BW5003-000A	230 VAC	UK Plug
BW5004-000A	230 VAC	SHUKO Plug
DUAL INLET		
BW5020-000A	115 VAC	US Plug
BW5022-000A	230 VAC	AUS Plug
BW5023-000A	230 VAC	UK Plug
BW5024-000A	230 VAC	SHUKO Plug



05 Electric Bag-in-Box Pumps

NEW

Bag in Box is a common, economical system for distributing drinks into the market. It is used worldwide and, because Flojet are a leading supplier of pumps to dispense all BIB liquids, we have a strong understanding of how to transfer your drinks from the BIB to the customer.

BevJet 5000 Series



FLOJET'S NEW BEVJET®

↘ Bag-In-Box Dispense System is designed for dispensing wine, juice, teas or liquor with alcohol content less than 15%. BEVJET® is ideal for beverage dispensing requiring frequent tube changes. The product dispenses safely through NSF Alcohol approved tubing and cleaning is as simple as replacing a tube. BEVJET senses when beverage box is empty and automatically shuts down. It restarts automatically when full supply is reconnected. The compact design enables mounting in tight spaces such as cabinets, carts, or most other under counter situations.

FEATURES AND BENEFITS

- ↘ Attractive appearance, can be installed anywhere.
- ↘ Vacuum switch - automatically shuts down the unit when the bag is empty and restarts the unit when a new bag is attached.
- ↘ NSF certification - ensures compliance with approved piping and fittings.
- ↘ Clearly identified "In" and "Out" ports with quick disconnects allow hose replacements in seconds.
- ↘ Flojet electric diaphragm pumping technology - ensures run dry capability, allowing for a long, trouble free service life.
- ↘ Thermal protection - avoiding costly service fees and peace of mind.
- ↘ Long life motor - outperforms many competitors by 400%.

STANDARD MODEL NUMBERS

MODEL NUMBER	VOLTAGE	FLOW RATE	MAX PRESSURE	POWER ADAPTER TYPE	COMPLIANCE
BIB5000A	115V	0.6 GPM (2.27 LPM)	40 psi (2.76 bar)	US Plug	NSF, UL
BIB5002A	230V	0.6 GPM (2.27 LPM)	40 psi (2.76 bar)	AU Plug	NSF, CE RoHS
BIB5003A	230V	0.6 GPM (2.27 LPM)	40 psi (2.76 bar)	UK Plug	NSF, CE RoHS
BIB5004A	230V	0.6 GPM (2.27 LPM)	40 psi (2.76 bar)	EU Plug	NSF, CE RoHS

2125 Series



APPLICATIONS

- ↳ Designed for dispensing Bag-in-Box syrups, juice concentrate (without pulp or particulate), teas, Bag-in-Box wines and liquor
- ↳ Ideal for use in mobile carts and vending applications, where CO₂ is not available

SPECIAL FEATURES

- ↳ Built-in vacuum switch shuts off pump when bag is empty. When full bag is connected, pump will restart automatically
- ↳ Pressure switch allows pump to turn on and off automatically when dispensing valve is opened or closed
- ↳ Self-priming up to 6 ft. (1.8 m)
- ↳ Runs dry without damage

STANDARD MODEL NUMBERS

MODEL NUMBER	VOLTAGE	PRESSURE SWITCH	OPERATIONAL
2125-030	115 Volt AC	50 psi max.	1 oz./sec. (3.4 bar) (29.5 ml./sec.)
2125-507	115 Volt AC	90 psi max.	0.5 oz./sec. (6.2 bar) (14.8 ml./sec.)
2125-230	230 Volt AC	50 psi max.	1 oz./sec. (3.4 bar) (29.5 ml./sec.)
2125-508	230 Volt AC	90 psi max.	0.5 oz./sec. (6.2 bar) (14.8 ml./sec.)

SPECIFICATIONS

PUMP DESIGN:	Double diaphragm
PORTS:	¼" (6.3 mm) NPT, female
MOTOR:	Permanent magnet with solid state rectifier
CYCLES:	50/60 Hz
RECOMMENDED DUTY CYCLE:	25%
APPROVALS:	NSF Standard 18 UL listed
WARRANTY:	1 Year

Note: Not available in Europe.

Note: If inlet exceeds 30 PSI (2.1 bar), pump requires 30 PSI (2.1 bar) water pressure regulator.

BevJet Compact



Bag-In-Box Dispense System is designed for dispensing wine, juice, teas or liquor.

MAIN FEATURES & BENEFITS BEVJET SERIES

- ↳ Quick, simple and easy to install
- ↳ NSF Certification, ensures compliance in typical beverage applications
- ↳ Quick disconnect ports, allows hose replacement in seconds and a range of options
- ↳ Built in shut-off, automatically shuts down the unit when the bag is empty run-dry technology and thermal protection, providing peace of mind & avoiding costly service calls
- ↳ Self Priming to allow mounting away from the beverage source

BEVJET COMPACT

- ↳ In addition to the main features, the BevJet Compact includes an easily accessible switch to restart when the beverage runs out and is more compact to allow fitting in most locations

BEVJET COMPACT BASE UNIT

MODEL NUMBER	VAC	PLUG
BLC1011-000A	115 VAC	US PLUG
BLC2011-000A	230 VAC	UK PLUG
BLC3011-000A	230 VAC	EU PLUG
BLC4011-000A	230 VAC	AU PLUG
BLC5011-000A	100-240 VAC	NO PLUG

06 General Pumps



Triplex Series High Pressure Pump



APPLICATIONS

- Water Booster
- Water Purification
- Espresso Brewing
- Carbonation

SPECIAL FEATURES

- Available pressures up to 150 psi (10.3 bar)
- Pump is sealed in corrosion resistant material, thus offering unparalleled performance and life
- Bypass System eliminates pulsation and cycling
- Latest co-injection mold diaphragm technology reduces potential leak paths
- No metal parts on wetted area

NEW STANDARD MODEL NUMBERS

MODEL NUMBER	DESCRIPTION
03811133	12 VDC 150 PSI (10.3 bar) 1.4 GPM (5.3 LPM)
03811143	12 VDC 150 PSI (10.3 bar) 1.4 GPM (5.3 LPM)
03811033	115VAC 150 PSI (10.3 bar) 1.4 GPM (5.3 LPM)
03811043	115VAC 150 PSI (10.3 bar) 1.4 GPM (5.3 LPM)
03811233	230VAC 150 PSI (10.3 bar) 1.4 GPM (5.3 LPM)
03811243	230VAC 150 PSI (10.3 bar) 1.4 GPM (5.3 LPM)
R3711143	12 VDC 100 PSI (6.9 bar) 1.4 GPM (5.3 LPM)
R3711343	24 VDC 100 PSI (6.9 bar) 1.4 GPM (5.3 LPM)
R3711243	230VAC 100 PSI (6.9 bar) 1.4 GPM (5.3 LPM)
R3811143	12 VDC 150 PSI (10.3 bar) 1.4 GPM (5.3 LPM)
R3811343	24 VDC 150 PSI (10.3 bar) 1.4 GPM (5.3 LPM)
R3811243	230VAC 150 PSI (10.3 bar) 1.4 GPM (5.3 LPM)

SPECIFICATIONS

MOTOR DESIGN (PMDC) AC:	Perm. Magnet TENV (non-ventilated)
VOLTAGES:	115, 230V AC, 12VDC and 24VDC
AMP DRAW:	1.2 Amps Max for 115VAC
PUMP HEAD:	Glass Filled Nylon
ELASTOMERS DIAPHRAGM:	Santoprene®
CHECK VALVES:	EPDM or Viton®
MAX. FLOW RATE:	1.4GPM (5.3LPM)
MAX. PRESSURE:	150 PSI (10.3 Bar)
DUTY CYCLE:	Intermittent*
WEIGHT:	7.6 lb (3.5 Kg)
PORT SIZE INLET / OUTLET:	3/8" NPTF
APPROVALS:	CE, NSF components

07 Beverage Solenoid Pumps

**NEW**

PS Series Oscillating Pumps

Building on our extensive experience in positive displacement pumps, Flojet's new PS Series Oscillating pumps provide a compact solution for low flow, high pressure applications.

Features.

- Pump Design: Oscillating Pump
- Outlet Port: 1/8" BSP - NPT Optional
- Inlet Port: 1/4" Hose Barb - BSP/NPT Optional
- Coil: Insulation Class II / Thermal Class "F"
- Body Material: Polyamide (Brass Optional)
- Seal Material: NBR / HNBR
- Regulatory: CE, UL, VDE

Performance data.

- Nominal Voltage: 110 / 230 VAC
- Liquid Temperature: Maximum 95°F (35°C)
- Pressure Rating: Up to 19 bar (276 psi)
- Flow Rating: Up to 1200 cm³/min (0.32 gal/min)

Typical applications.

- Espresso Coffee Makers
- Floor Care Machines
- Steam Irons
- Steam Generators
- Steam Cleaning Systems
- Medical Appliances
- Water Dispensers
- Air Conditioners
- Cooling Systems



Data table.

Part No.	Max. Pressure Rating (bar)	Max. Pressure Rating (psi)	Max. Flow (cm ³ /min)	Max. Flow (gallon/min)	Voltage (VAC)	Frequency (Hz)	Port / Elastomer Material
PS0311	3	44	1200	0.32	120	60	NBR
PS0321	3	44	1200	0.32	230	50	NBR
PS0411	4	58	950	0.25	120	60	NBR
PS0421	4	58	950	0.25	230	50	NBR
PS0711	7	102	1000	0.26	120	60	NBR
PS0721	7	102	1000	0.26	230	50	NBR
PS1511	15	218	650	0.17	120	60	NBR
PS1521	15	218	650	0.17	230	50	NBR
PS2011	19	276	420	0.11	120	60	NBR
PS2021	19	276	420	0.11	230	50	NBR

Accessories.

Part No.	Description
PSA0100	Inlet Elbow Hose Adapter
PSA0101	Inlet Adapter - 1/8"
PSA0200	Rubber Pump Mount - PVC - < 50° C
PSA0201	Rubber Pump Mount - SEBS - < 100° C

Extensive range of other accessories available on request.
Please contact your local xylem sales office.

Nomenclature.

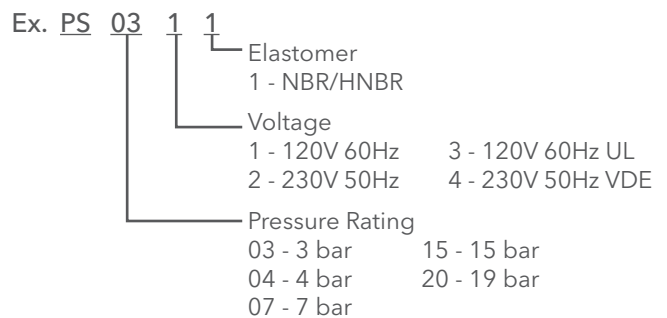

08 Filtration

C Series Water Filtration Range

Features.

- Compact
- Best lifetime cost per gallon
- Expandable
- Easy and fast to service/change out
- High flow rates - up to 5 GPM through 1 head
- Retrofit models available
- Optional scale inhibitor available
- Optional chloramine reduction available

Applications.

Hot & Cold Beverage and Ice machines

C1-2500000

Applications.

for sediment, chlorine taste & odor reduction in Single Carbonators

CAPACITY.	37,850 (Litres) 10,000 (Gallons)
MICRON RATING.	1
LENGHT.	349 (mm) 13-4/4 (inches)
DIAMETER.	3-5/16 (inches) 83 (mm)



C1-2510000

Applications.

ice machines.

CAPACITY.	37,850 (Litres) 10,000 (Gallons)
MICRON RATING.	1
LENGHT.	330,2 (mm) 13-3/4 (inches)
DIAMETER.	76,2 (mm) 3-5/1 (inches)



C1-3500000

Applications.

for sediment, chlorine taste & odor reduction in Single Carbonators

CAPACITY.	47,696 (Litres) 12,600 (Gallons)
MICRON RATING.	1
LENGHT.	455 (mm) 17-15/16 (inches)
DIAMETER.	3-5/16 (inches) 83 (mm)



C1-4500000

Applications.

for sediment, chlorine taste & odor reduction in Single Carbonator with non-carb dispenser

CAPACITY.	94,635 (Litres) 25,000 (Gallons)
MICRON RATING.	5
LENGHT.	298 (mm) 11-3/4 (inches)
DIAMETER.	4-7/16 (inches) 114 (mm)



C1-6500000

Applications.

for sediment, chlorine taste & odor reduction in Twin Carbonators

CAPACITY.	132,489 (Litres) 35,000 (Gallons)
MICRON RATING.	3
LENGHT.	375 (mm) 14-3/4 (inches)
DIAMETER.	4-7/16 (inches) 114 (mm)



C1-9500000

Applications.

for sediment, chlorine taste & odor reduction in Triple Carbonators

CAPACITY.	204,390 (Litres) 54,000 (Gallons)
MICRON RATING.	3
LENGHT.	527 (mm) 20-3/4 (inches)
DIAMETER.	4-7/16 (inches) 114 (mm)



C1-6520000

Applications.

for sediment, chloramines, chlorine taste & odor reduction in Twin Carbonators

CAPACITY.	Chlorine 264,980 Chloramine 26,498 (Litres) Chlorine 70,000 Chloramine 7,000 (Gallons)
MICRON RATING.	3
LENGHT.	375 (mm) 14-3/4 (inches)
DIAMETER.	4-7/16 (inches) 114 (mm)



C1-9520000

Applications.

for sediment, chloramines, chlorine taste & odor reduction in Triple Carbonators

CAPACITY.	Chlorine 454,249 Chloramine 113,550 (Litres) Chlorine 120,000 Chloramine 30,000 (Gallons)
MICRON RATING.	3
LENGHT.	527 (mm) 20-3/4 (inches)
DIAMETER.	4-7/16 (inches) 114 (mm)



C2-3500000

Applications.

for sediment, chlorine taste & odor reduction in Single Carbonators

CAPACITY.	47,696 (Litres) 12,600 (Gallons)
MICRON RATING.	1
LENGHT.	365 (mm) 14.375 (inches)
DIAMETER.	3.375 (inches) 86 (mm)



C2-3510000

Applications.

for sediment, chlorine taste & odor reduction in Single Carbonators

CAPACITY.	47,696 (Litres) 12,600 (Gallons)
MICRON RATING.	1
LENGHT.	365 (mm) 14.375 (inches)
DIAMETER.	3.375 (inches) 86 (mm)



HN3-12B000 and HN3-12N000







Filter Head with gauge port

FLOW RATE	5 (gpm) 18.9 (lpm)
PORT TYPE	1/2 BSP or 1/2 NPT

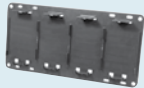

09 Accessories & Fittings

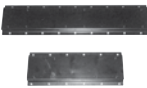
Mounting Brackets

PART NUMBER	DESCRIPTION AND FEATURES
20982-100A 	UNIVERSAL BRACKET <ul style="list-style-type: none"> • For use with N & T Series, G Series and Shurflo®, air driven pumps • Single brackets snap together easily for multiple pump installations • Ideal for mounting on BIB rack or wall
21000-255B 	TRANSFER VALVE MOUNTING BRACKET (12 PK.) <ul style="list-style-type: none"> • For mounting transfer valve onto N & T Series pump or on 8 Pump • Stainless Steel Mounting Panel
21000-296A 	FOUR PUMP PLASTIC MOUNTING BRACKET <ul style="list-style-type: none"> • For use with all G Series pumps • Ideal for mounting on BIB rack or wall
11028-008 	EIGHT PUMP STAINLESS STEEL MOUNTING PANEL <ul style="list-style-type: none"> • For use with N & T Series pumps • Mounting positions available for air regulators and transfer valves
21000-563 	90° SLIDE BRACKET <ul style="list-style-type: none"> • Mounted on a 90° angle • Allows quick mounting of pump to 90° angle style mounting systems
11028-508 	THREE PUMP METAL MOUNTING BRACKET <ul style="list-style-type: none"> • For use with N & T Series pumps • Bracket can be mounted vertically or horizontally • Black enamel finish resists corrosion • Ideal for mounting on BIB rack or wall
20272-002B 	SLIDE TRACK BRACKET <ul style="list-style-type: none"> • For use with N & T Series air driven pump • Allows quick mounting of pump to slide-in style mounting systems

Transfer Valves

General Information

VALVE HIGHLIGHTS

- Automatically changes from empty to full bag without interrupting flow
- Can operate multiple banks of BIB, horizontally
- Label indicates which BIB is "on-line"
- Can be mounted in any position
- Can be manually operated



STANDARD MODEL NUMBERS

PART NUMBER	DESCRIPTION
1500-030	Regular-automatic switching @ 16" (406.4 mm) (+ or - 2"(50.8mm)) Hg.
1500-130	Regular with swivel elbow fittings
1500-031	High altitude, 3,000+ ft. (900+ m); automatic switching @ 11"(279.4 mm) - 14'(4.3 m) Hg.
1500-131	High altitude with swivel elbow fittings
1500-050	Regular-automatic switching @ 16"(406.4mm) (+ or - 2"(50.8mm)) Hg, 1/2" ports

SPECIFICATIONS

DESIGN:	Vacuum Operated, Snap Action Diaphragm
CONNECTIONS:	3/8" (9.5 mm) Hose Barb
APPROVALS:	NSF Standard 18

Syrup Sold Out Switch

General Information

SPECIAL FEATURES

- Illuminates "sold out" light to indicate empty BIB and temporarily disables dispensing valve

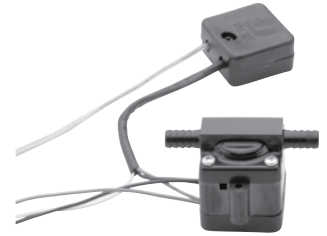

STANDARD MODEL NUMBERS

PART NUMBER	DESCRIPTION
2095-502	Syrup Sold Out Switch, for 1/4" (6.3 mm) ID tubing
2095-540	Syrup Sold Out Switch, for 3/8" (9.5 mm) ID tubing

SPECIFICATIONS

DESIGN:	Pressure/Electrical Operation
PRESSURE SWITCH:	Opened 20 psi (1.4 bar), Closed 13 psi (0.9 bar). Normally open
VOLTAGE:	24 Volt AC power
CYCLE:	50/60 Hz
CONNECTIONS:	1/4" (6.3 mm) OD or 3/8" (9.5 mm) OD hose barbed
APPROVALS:	NSF Standard 18, UL listed

Auto Shut Off

General Information

APPLICATIONS

- For use with T5000 Series pumps
- Automatically shuts off pump when BIB bag is empty
- NSF Standard 18

STANDARD MODEL NUMBERS

PART NUMBER	DESCRIPTION
20308-130	Auto shutoff valve, 1/4" (6.3 mm) plastic straight CO ₂ shutoff valve
20308-131	High altitude auto shutoff valve, 1/4" (6.3 mm) plastic straight CO ₂ shutoff valve

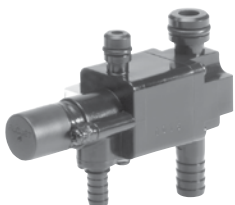

Vacuum Switch

General Information

APPLICATIONS

- Signal 'sold out' situation in BIB suction lines
- 0.375" Barbed connections
- Normally open contacts

STANDARD MODEL NUMBERS

PART NUMBER	DESCRIPTION
02095116	KIT VAC SW (N/O) .375 BASE switching @ 16" Hg + or - 2" Hg

Gas Pump Liquid Fittings

STAINLESS STEEL PRODUCT INLETS & OUTLETS

For use with

N, T, G55, G5A, G58 AND LF PLUS SERIES PUMPS

STANDARD MODEL NUMBERS

PART NUMBER	DESCRIPTION
20324-030	¼" (6.3 mm) Hose Barb, Straight
20325-030	¾" (9.5 mm) Hose Barb, Straight
20606-100	½" (12.7 mm) Hose Barb, Straight
20607-100	¼" (6.3 mm) Hose Barb, Elbow
20608-100	¾" (9.5 mm) Hose Barb, Elbow

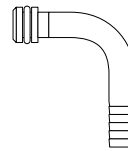
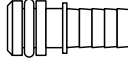

For use with

G56 AND K56 SERIES PUMPS

STANDARD MODEL NUMBERS

PART NUMBER	DESCRIPTION
21000-131A	¼" (6.3 mm) Hose Barb, Straight
221000-130A	¾" (9.5 mm) Hose Barb, Straight

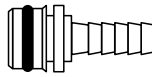

Plastic Product Outlet & Inlets

For use with

N, T, G55, G5A, G58 AND LF PLUS SERIES PUMPS

STANDARD MODEL NUMBERS

PART NUMBER	DESCRIPTION
20325-031	¾" (9.5 mm) Hose Barb, Straight

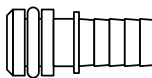

For use with

ALL G56 SERIES AND K56 SERIES PUMPS

STANDARD MODEL NUMBERS

PART NUMBER	DESCRIPTION
20381-026	10-13mm (¾"-½") Hose Barb, Straight
20381-002	½" (12.7 mm) Hose Barb, Straight
20381-024	10-13mm (¾"-½") Hose Barb, Elbow
20381-009	½" (12.7 mm) Hose Barb, Elbow

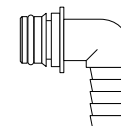
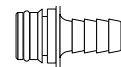
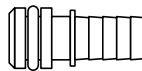

Gas Pump Air Fittings

BRASS CO₂/AIR INLETS WITH SHUTOFF VALVE

For use with

ALL N5000 SERIES AND G SERIES PUMPS

STANDARD MODEL NUMBERS

PART NUMBER	DESCRIPTION
1510-000	¼" (6.3 mm) Hose Barb, Straight
1520-000	¼" (6.3 mm) Hose Barb, Tee
1521-000	¼" (6.3 mm) Hose Barb, Elbow

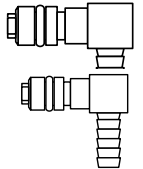
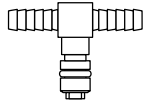

Offset Brass CO₂/Air Inlets W/Shutoff Valve

APPLICATIONS

- Facilitates manifolding CO₂ lines of multi-pump kits, when pumps are mounted vertically.
- Eliminates obstruction of CO₂/airlines by fluid lines or ports.

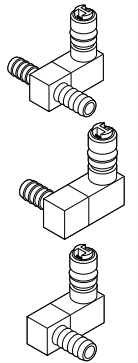

STANDARD MODEL NUMBERS

PART NUMBER	DESCRIPTION
91010-002	¾" NPT Male x ¾" (9.5 mm) Barb
91010-004	¼" NPT Male x ¾" (9.5 mm) Barb
91010-006	¾" NPT Male x ½" (12.7 mm) Barb
91010-032	¾" NPT Male x ¼" (6.3 mm) Barb
91010-053	¼" NPT Male x ¼" (6.3 mm) Barb

Plastic CO₂/Air Inlets

For use with

ALL N5000 SERIES AND G SERIES PUMPS

STANDARD MODEL NUMBERS

PART NUMBER	DESCRIPTION
20325-033	¼" (6.3 mm) Hose Barb, Straight

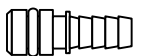

John Guest Fittings

PRODUCT INLET AND OUTLET FITTINGS

For use with

N, T, G55, G5A, G58 AND LF PLUS SERIES PUMPS

STANDARD MODEL NUMBERS

PART NUMBER	DESCRIPTION
21000-231B	For use with 1/4" (6.3 mm) O.D. Tubing
21000-232B	For use with 3/8" (9.5 mm) O.D. Tubing

* Packaged 12 per bag

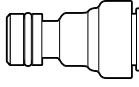
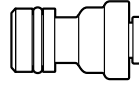

For use with

G56 AND K56 SERIES PUMPS

STANDARD MODEL NUMBERS

PART NUMBER	DESCRIPTION
21000-228B	For use with 1/4" (6.3 mm) O.D. Tubing
21000-229B	For use with 3/8" (9.5 mm) O.D. Tubing
21000-230B	For use with 1/2" (12.7 mm) O.D. Tubing

* Packaged 12 per bag

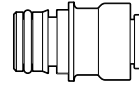
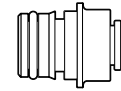
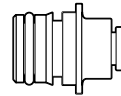

For use with

ALL N5000 SERIES AND G SERIES PUMP

STANDARD MODEL NUMBERS

PART NUMBER	DESCRIPTION
21000-233B	Plastic Fitting, for use with 1/4" (6.3 mm) OD tubing
21000-234B	Brass CO ₂ Fitting with shutoff, for use with 1/4" (6.3 mm) O.D. tubing

* Packaged 12 per bag

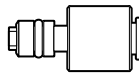
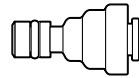

Electric Fittings

For use with

ALL DUPLEX II AND 2820 SERIES (3/8" NPT ONLY) AND 2125 SERIES PUMPS (1/4" NPT ONLY)

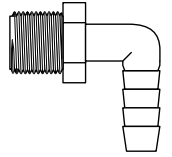

STANDARD MODEL NUMBERS

PART NUMBER	DESCRIPTION
91010-001	3/8" NPT Male x 3/8" (9.5 mm) Barb
91010-003	1/4" NPT Male x 3/8" (9.5 mm) Barb
91010-005	3/8" NPT Male x 1/2" (12.7 mm) Barb
91010-033	3/8" NPT Male x 1/4" (6.3 mm) Barb
91010-052	1/4" NPT Male x 1/4" (6.3 mm) Barb

Nylon Barbed Straight

For use with

ALL DUPLEX II AND 2820 SERIES (3/8" NPT ONLY) AND 2125 SERIES PUMPS (1/4" NPT ONLY)

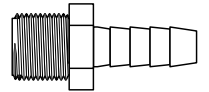

STANDARD MODEL NUMBERS

PART NUMBER	DESCRIPTION
91010-002	3/8" NPT Male x 3/8" (9.5 mm) Barb
91010-004	1/4" NPT Male x 3/8" (9.5 mm) Barb
91010-006	3/8" NPT Male x 1/2" (12.7 mm) Barb
91010-032	3/8" NPT Male x 1/4" (6.3 mm) Barb
91010-053	1/4" NPT Male x 1/4" (6.3 mm) Barb

Xylem |'zīləm|

- 1) The tissue in plants that brings water upward from the roots;
- 2) a leading global water technology company.

We're a global team unified in a common purpose: creating innovative solutions to meet our world's water needs. Developing new technologies that will improve the way water is used, conserved, and re-used in the future is central to our work. We move, treat, analyze, and return water to the environment, and we help people use water efficiently, in their homes, buildings, factories and farms. In more than 150 countries, we have strong, long-standing relationships with customers who know us for our powerful combination of leading product brands and applications expertise, backed by a legacy of innovation.

For more information on how Xylem can help you, go to www.xylem.com

FLOJET



foodservice.xylem.com

CHINA
32/F Tower A, Hongqiao City
Centre of Shanghai,
100 Zunyi Road,
Shanghai 200051, China
Tel: (86)21 2208 2888
Fax: (86)21 2208 2999

GERMANY
Oststraße 28,
22844 Norderstedt, Germany
Tel: +49 (0) 40 53 53 730
Fax: +49 (0) 40 53 53 73 11

ITALY
Via Tommaseo, 6, 20059
Vimercate, Milano, Italy
Tel: +39 039 6852323
Fax: +39 039 666307

UNITED STATES
SA - West Coast
17942 Cowan,
Irvine, CA 92614
Tel: +1 949 608 3900
Fax: +1 949 608 3888



Xylem
Bingley Road, Hoddesdon
Hertfordshire EN11 0BU
United Kingdom
Tel: +44 (0)1992 450145
Fax: +44 (0)1992 467132
www.xylem.com

Flojet is a trademark of Xylem Inc. or one of its subsidiaries.
© 2016 Xylem

P10/16

ACCURACY AND COMPLETENESS OF INFORMATION

All information in this literature regarding products and services provided by Flojet is subject to change without prior notice. Reasonable efforts are taken to ensure the accuracy and integrity of all information provided here, but Flojet is not responsible for misprints, out-of-date information, or errors. Flojet makes no warranty, express or implied, or assumes any legal liability or responsibility for the accuracy or completeness of any information contained in this literature.