



- M18 cylindrical type compatible with European Standards (CENELEC)
- Polarization reflector type capable of detecting mirror-like objects
 - Thorough short circuit protection
 - Water resistance of IP 66 achieved by resin molding
 - Dramatic improvement of environment resistance including prevention of damage and falling off electronic components caused by vibration and enhanced robustness

Type

Detection method	Detecting distance	Model		Operation mode	Output mode	Remarks
		NPN type	PNP type			
Through-beam type 	3m	CXT8 [※]	CXT8PN [※]	Light-ON /Dark-ON selectable (with control lead)	Open collector	Infrared LED long-distance type
Polarization reflector type 	2 m max.	CX-M2RD	CX-M2RDPN	Dark-ON		Red LED capable of detecting mirror-like objects
Diffuse-reflective type 	100 mm max.	CX-R01	CX-R01PN	Light-ON		Infrared LED
	300 mm max.	CX-R03V	CX-R03VPN		Infrared LED type provided with adjustment for ease of fine detection	

*Connector connection models convenient for mounting and wiring also available

Models CXT8-J, CXT8PN-J

Cord with connector separately available required for connector connection models

Model CX-C4 — 4-core, 2.5 m

Rating/Performance/Specification

Model	NPN type	CXT8	CX-M2RD	CX-R01	CX-R03V
	PNP type	CXT8PN	CX-M2RDPN	CX-R01PN	CX-R03VPN
Detection method		Through-beam type	Polarization reflector type	Diffuse-reflective type	
Detecting distance		3m	2m*1	100mm *2	300mm *3
Detection object		φ 15mm (Min.) Opaque	Mirror-like objects / opaque objects / translucent objects	Opaque objects / translucent objects	
Power supply		12 - 24V DC ±10% / Ripple 10% max.			
Current consumption	NPN type	Transmitter: 25 mA max. Receiver: 15 mA max.	20mA max.	17mA max.	20mA max.
	PNP type	Transmitter: 25 mA max. Receiver: 20 mA max.	24mA max.	23mA max.	26mA max.
Output mode	NPN type	Open collector Rating: sink current 100 mA (30 VDC) max.			
	PNP type	Open collector Rating: source current 100 mA (30 VDC) max.			
Operation mode		Light-ON/Dark-ON selectable (with control lead)	Dark-ON	Light-ON	
Response time		1ms max.	0.35ms max.		
Operating angle		7° (at receiver)	10° (at receiver)	_____	
Hysteresis		_____		5% max.	
Light source (wavelength)		Infrared LED (940nm)	Red LED (700nm)	Infrared LED (950nm)	
Indicator		Transmitter: Power indicator (red LED) Receiver: Light reception indicator (red LED)	Operation indicator (red LED)		
Volume		_____			Sensitivity adjustment
Short circuit protection		Provided			
Material		Lens: Polycarbonate Case: Polycarbonate	Lens: Acrylic Case: Polycarbonate	Lens: Polycarbonate Case: Polycarbonate	
Connection		Permanently attached cord (outer diameter: 4 mm) Transmitter: 0.2 sq. 2 core 2 m length (gray) Receiver: 0.2 sq. 4 core 2 m length (black)	Permanently attached cord (outer dimension: dia. 4) 0.2sq. 3 core 2 m length (black)		
Mass		Transmitter: About 65 g Receiver: About 65 g	About 65 g		
Notes		Slit plate (optional) 3 x 10, 4 x 10, 5 x 10 in 1 set	K-7 reflector provided	_____	

*1 With K-7 reflector

*2 With 50 x 50 mm white drawing paper

*3 With 100 x 100 mm white drawing paper

Environmental Specification

Ambient light	10,000 lx max. (5,000 lx max. for through-beam type)
Ambient temperature	-25 - +55°C (non-freezing)
Ambient humidity	35 - 85%RH (non-condensing)
Protective structure	IP66
Vibration	10 - 55 Hz / 1.5 mm amplitude / 2 hours each in 3 direction
Shock	100 m/s ² / 3 times each in 3 directions
Dielectric withstanding	500 VAC for 1 minute
Insulation resistance	500 VDC, 20 MΩ or higher

Applicable power supply unit

PS Series
High capacity of 200 mA at 12 VDC

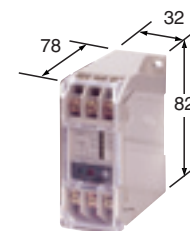

(General-purpose type) PS3N
PS3N-SR
(Multifunctional type) PS3F
PS3F-SR

Input/Output Circuit and Connection

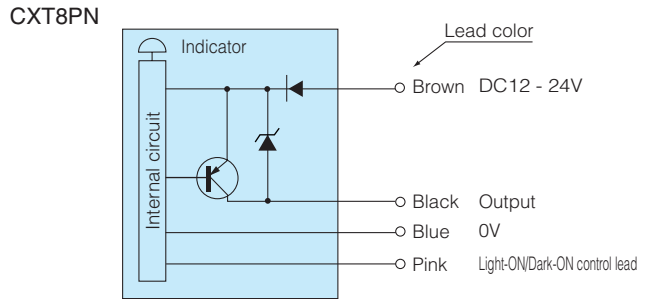
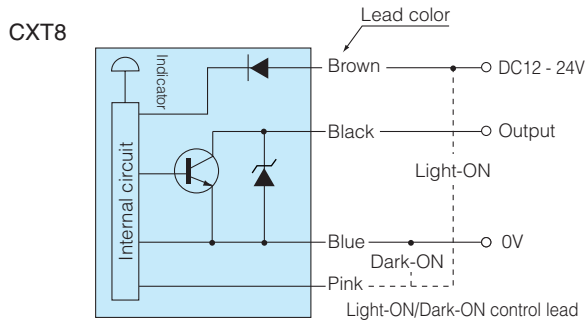

CX-M2RD NPN output
CX-R01
CX-R03V

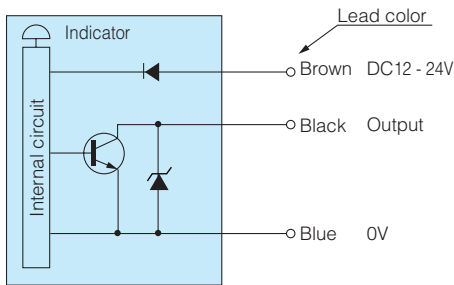

CX-M2RDPN PNP output
CX-R01PN
CX-R03PN

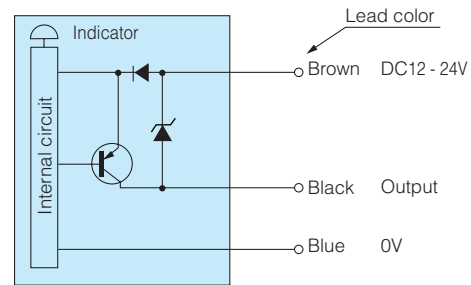

• The output transistor turns off when load short circuit or overload occurs. Check the load and turn the power back on.

Characteristics (Typical Example)

• Directional characteristics

CXT8

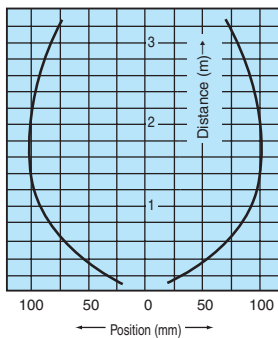

CX-M2RD · CX-M2RDPN

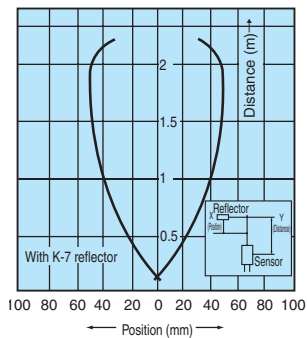

CX-R01 · CX-R01PN

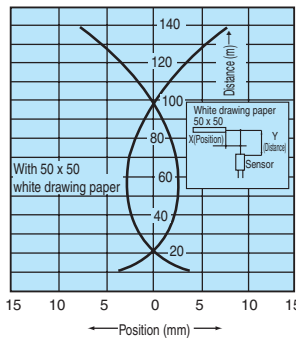

CX-R03V · CX-R03VPN

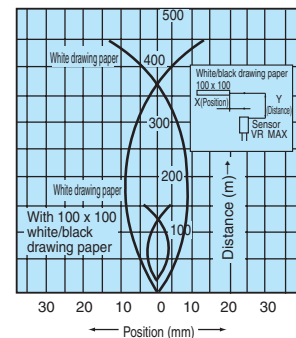

• Operating angle characteristics

CXT8 (PN)

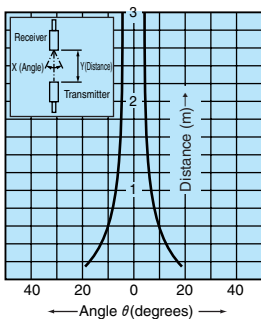

• Distance-output characteristics

CX-R01 · CX-R01PN

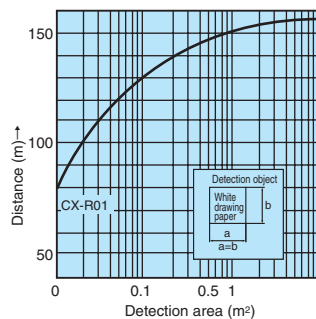

CX-R03V · CX-R03VPN

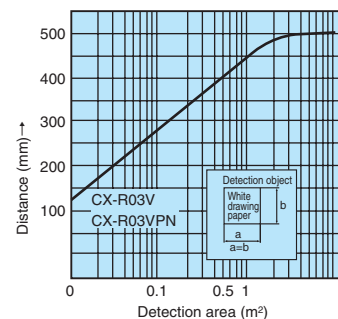

Temperature characteristics

CX-M2RD
CX-M2RDPN

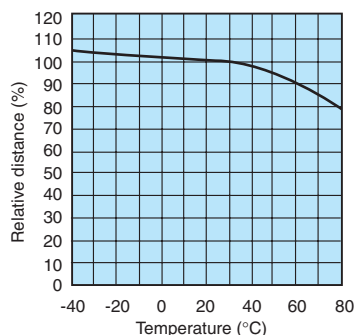

CX-R01
CX-R01PN
CX-R03V
CX-R03VPN

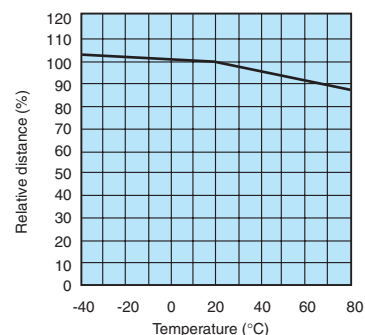

Dimensions (in mm)

CAD

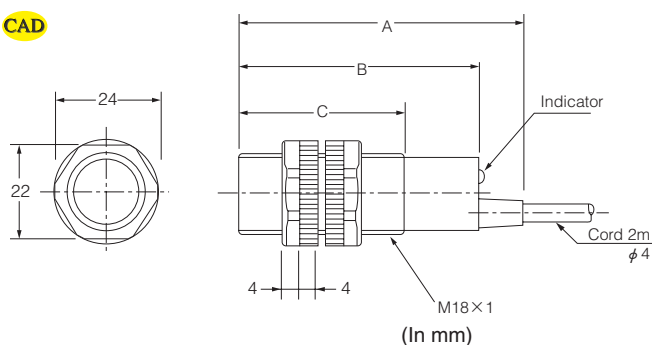

Model	A	B	C
CX-M2RD CX-M2RDPN	66.2	56.2	38.2
CXT8 CX-R01 CX-R01PN CX-03V CX-R03VPN	65	55	37

CAD

K-7 reflector

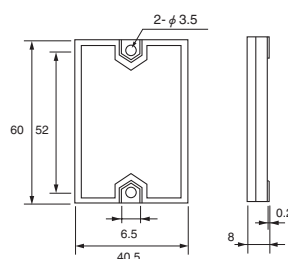

(Applicable to polarization reflector type)
Effective reflecting surface : 56 x 36 mm
Mounting: secured with M3 screws
(alternatively adhesive may be used)
Protective structure: IP 67

(Notes on mounting)

- Excessive tightening torque may damage the thread of the nut to cause loosening. Make sure that the tightening torque is up to 0.98 N·m.
- This sensor does not allow adjustment of mounting angle once it is secured. Pay attention to the light axis especially for through-beam types to avoid misalignment.

Setting

(Through-beam type)

- For light axis alignment, swivel the receiver vertically and horizontally to install it at the center of the area in which the light reception indicator (red LED) is illuminated for the individual direction.
- Repeat activation and deactivation to check the operation.

(Polarization reflector type)

- Arrange the sensor in line with the reflector. Swivel the sensor vertically and horizontally with reference to the reflector, use the operation indicator to check the area in which the sensor is activated (indicator goes out) and install the sensor at the center of the area. Taking advantage of the red light spot on the reflector seen from behind the sensor allows easy setting.

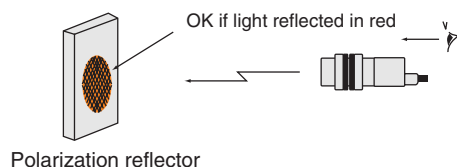

(Diffuse-reflective type)

- Set the sensor so that the operation indicator (red LED) is illuminated with the detection object placed at a given position and not illuminated with the object removed.
- Bring any background of the detection object as far away as possible or use black surface with low reflectance.
- The detecting distance depends on the surface condition of the detection object. This sensor is not provided with a sensitivity adjustment volume and needs to be adjusted for stable operation by changing the distance, angle, background object, etc.

(Diffuse-reflective type with adjustment)

- Adjustment with any light-reflecting object in the background
 - Place the object to be detected in a given position, turn up the sensitivity adjustment volume (SENS) gradually from the minimum (MIN) and find the point at which the operation indicator (red LED) is illuminated (Point A).
 - Remove the object, turn down the sensitivity adjustment volume gradually from the maximum (MAX) and find the point at which the operation indicator (red LED) goes out (Point B). (If the operation indicator is not illuminated even at MAX, MAX is regarded as Point B.)
 - Set the volume at midway between Points A and B.

