

- According to DIN EN 61810-1, DIN EN 61810-3 (Type A resp. Type B)
- With forcibly guided contacts
- Clearance and creepage distances:
Contact - coil ≥ 8 mm,
Contact - contact ≥ 5.5 mm
- **Double and reinforced insulation between contact sets**
- Low rated power consumption
- High mechanical service life
- For high ambient temperature up to $+ 85$ °C
- Compact size, small height
- As option wash proof RT III

Applications

- Switchgear for safety technology
- Press controls

Approvals and Markings



Technical Data

Relaistyp	OA 5669
1.0 Relay coil	
1.1 Nominal voltage	DC 6; 12; 24; 48; 60; 110 V (others on request)
1.2 Nominal consumption	0.8 W
1.11 Voltage range	0.75 ... 1.4 U _N
1.13 Holding Power (at 0.5 x U _N)	0.2 W
2.0 Contacts	
2.1 Contact arrangements	2 changeover contacts (Type B), 1 NC and 1 NO (Type A)
2.2 Contact material	AgSnO ₂ + 0.2 µm Au; AgNi + 0.2 µm Au, AgNi + 5 µm Au
2.3 Rated insulation voltage	AC 250 V
Switching voltage min./max.	AC/DC 10 V / DC 250 V, AC 400 V (AC/DC 2 V / 60 V) ¹⁾
2.4 Limiting continuous current I _{th}	2 x 5 A (see operating voltage limit curve)
Switching current min./max.	10 mA ³⁾ / 8 A (2 mA / 0.3 A) ¹⁾
2.5 Switching power min./max.	0.1 VA / 2000 VA (10 mVA / 12 VA) ¹⁾
Switching power min./max.	0.1 W ³⁾ / 200 W (10 mW / 12 W) ¹⁾ (s. limit curve for arc-free operation)
2.6 Switching capacity to IEC/EN 60947-5-1	
AC 15 ⁴⁾	NC: AC 250 V / 1 A NO: AC 250 V / 2 A
AC 15 ⁵⁾	NC: AC 250 V / 2 A NO: AC 250 V / 3 A
DC 13 ⁴⁾	NC: DC 24 V / 1 A NO: DC 24 V / 1 A
DC 13 ⁴⁾ at 0.1 Hz	NC: DC 24 V / 4 A NO: DC 24 V / 4 A
to UL 508	R300
2.7 Electrical life	At 1 s On, 1 s Off (see contacts service life)
at AC 230 V, 6 A, cosφ = 1	> 2 x 10 ⁵ switching cycles AgNi > 2 x 10 ⁵ switching cycles AgSnO ₂
2.8 Max. switching frequency	10 switching cycles/s
2.9 Response time / Release time	Typically 15 ms / Typically 5 ms
2.10 Contact force NO / NC	≥ 13 cN / ≥ 10 cN
2.14 Contact gap	> 0.5 mm ⁶⁾
3.0 Other	
3.1 Mechanical life	≥ 50 x 10 ⁶ switching cycles
3.2 Temperature range	- 40 ... + 85 °C mounted without distance (I _{th} = 2 x 5 A)
3.3 Degree of protection	Solder line proof RT II as option wash proof RT III
3.4 Test procedure	A (group mounting)
3.5 Vibration resistance	10 ... < 60 Hz; 1,2 mm Amplitude; (NO contact) IEC/EN 60068-2-6 10 ... < 60 Hz; 0,35 mm Amplitude; (NC contact) IEC/EN 60068-2-6 60 ... 200 Hz, ≤ 10 g (NO contact) IEC/EN 60068-2-6 60 ... 200 Hz, ≤ 3 g (NC contact) IEC/EN 60068-2-6
3.6 Climate resistance	40 / 085 / 04; A/B/D IEC/EN 60068-1
3.7 Short circuit strength 1 kA / AC 250 V	AgSnO ₂ 10 A gG / gL IEC/EN 60947-5-1 AgNi 6 A gG / gL IEC/EN 60947-5-1

¹⁾ Values for AgNi-contacts + 5 µm Au

²⁾ 10 A total current at t = 20 °C and coil voltage = U_N

³⁾ Typical values for AgSnO₂ and AgNi

⁴⁾ Values for AgNi-contacts

⁵⁾ Values for AgSnO₂-contacts

⁶⁾ Over entire service life acc. to DIN EN 61810-3

Technical Data

3.8	Insulation acc. to IEC 60664-1, EN 50178	Double and reinforced insulation
	Rated insulation voltage	AC 250 V
	Pollution degree	2
	Overtoltage category	III
	Test voltage	
	Contact-coil (1 min)	≥ AC 4 kV eff.
	Contact-contact (1 min)	≥ AC 4 kV eff.
	Contact open (1 min)	≥ AC 1.5 kV eff.
	Transient voltage	
	Contact-coil (1.2 - 50 μs)	≥ 6 kV
	Clearance and creepage distances	
	Contact-coil	≥ 8 mm
	Contact-contact	≥ 5.5 mm
3.9	Weight	Approx. 19 g
4.0 Packing		
4.1	On cardboard	56 pieces
4.2	In case package	280 pieces
5.0 Solder method		
5.1	Solder method /-temperature /-duration	Wave soldering / 260 °C / 5 s

Design versions

U _N (DC V)	Voltage range (DC V)	R _{Coil} Ω ± 10%	AgNi-contacts + 0,2 μm Au		
			OA 5669.12	OA 5669.16	
6	4,5 ... 7,8	44	3001	3011	3501
12	9,0 ... 16,8	175	3002	3012	3502
24	18,0 ... 33,6	720	3003	3013	3503
48	36,0 ... 67,0	2880	3004	3014	3504
60	45,0 ... 84,0	4500	3005	3015	3505
110	82,0 ... 154	15000	3006	3016	3506
				1)	2)

U _N (DC V)	AgNi - contacts + 5 μm Au			AgSnO ₂ - contacts + 0,2 μm Au		
	OA 5669.12	OA 5669.16		OA 5669.12	OA 5669.16	
6	3031	3041	3511	3061	3071	3521
12	3032	3042	3512	3062	3072	3522
24	3033	3043	3513	3063	3073	3523
48	3034	3044	3514	3064	3074	3524
60	3035	3045	3515	3065	3075	3525
110	3036	3046	3516	3066	3076	3526
		1)	2)		1)	2)

1) = Pin configuration standard

2) = Pin configuration reverse

Ordering Example

OA 5669. _ / 3 _ _ _ / 61*)

- Pin configuration
- L = Solder line proof RT II
- W = Wash proof RT III
- Design version
- Ambient temperature up to + 85 °C
- Contacts
 - .02 = 2 NO (Type A)
 - .16 = 1 NO, 1 NC (Type A)
 - .12 = 2 changeover cont. (Type B)
 - .20 = 1 NO, 1 changeover con. (Type B)
- Relay type

Notes

For the use and processing of our PCB relays, please refer to the **application and processing instructions** at www.dold.com

*) /61 cURus approval

Characteristics

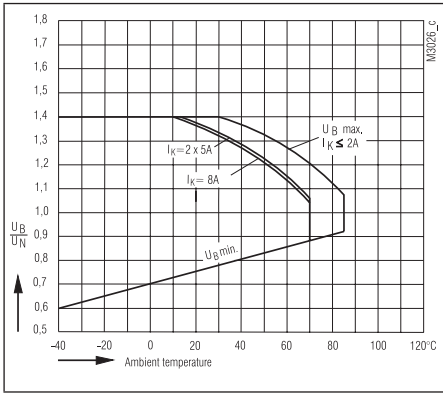

Operating voltage limit curve

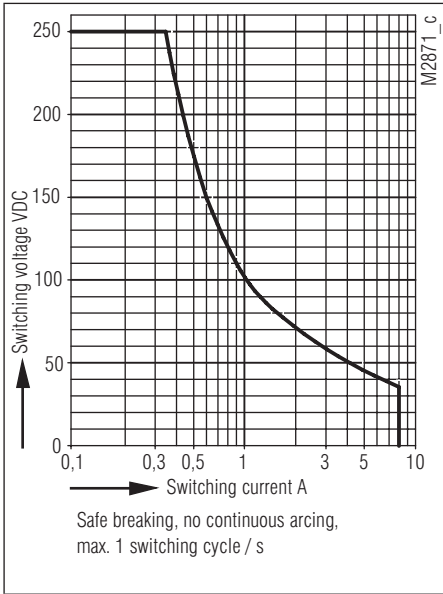

Arc limit curve

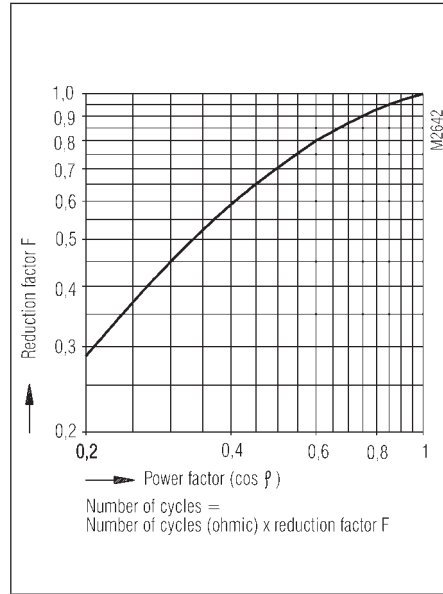

Reduction factor for reactive loads

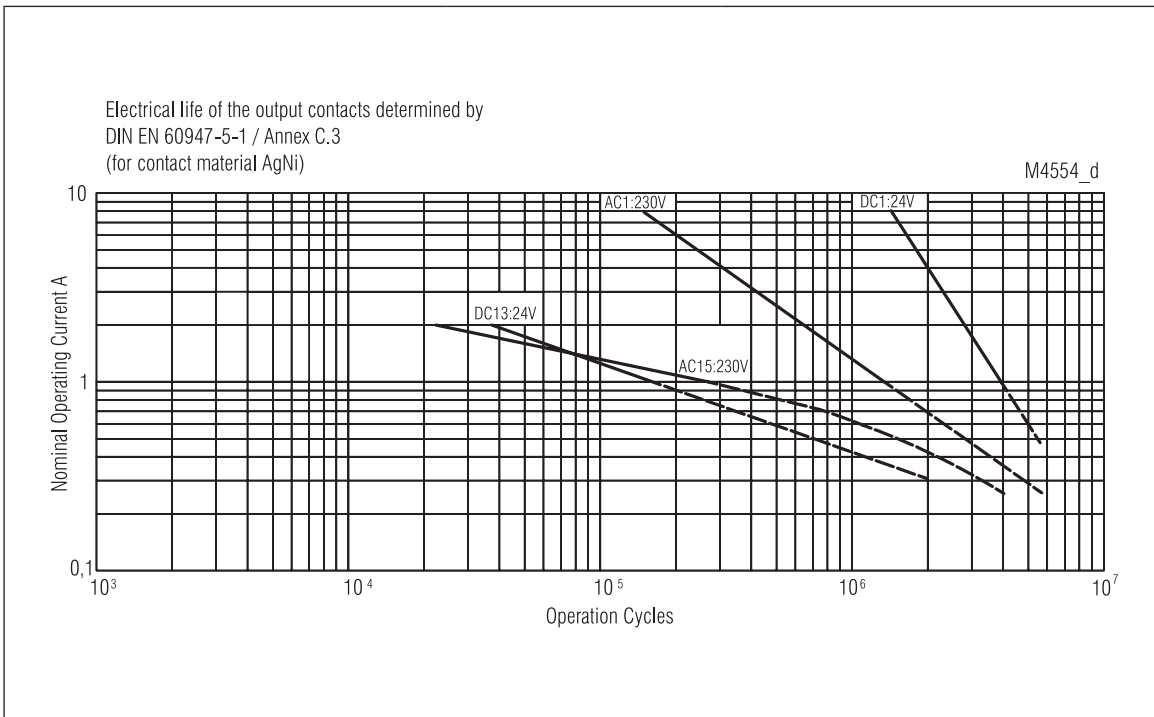

Electrical life for contact material AgNi

Bohrbild (Lötseite)

Pin configuration standard

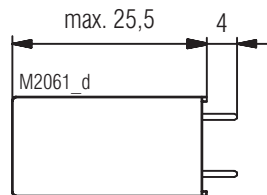
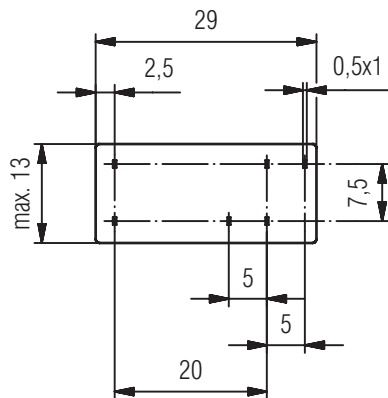
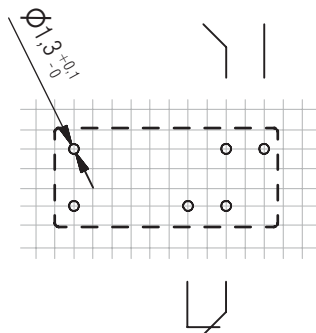

M2061_d
OA5669.16
OW5669.16

Pin configuration reverse

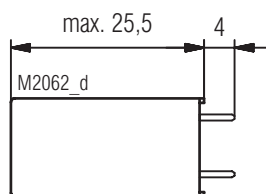
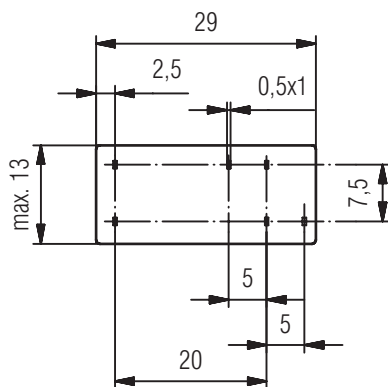
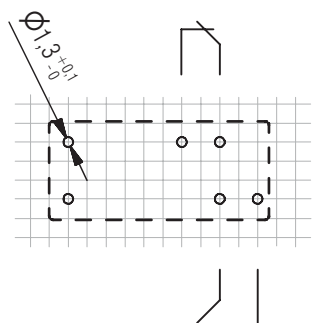

M2062_d
OA5669.16
OW5669.16

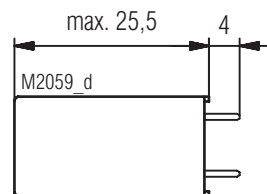
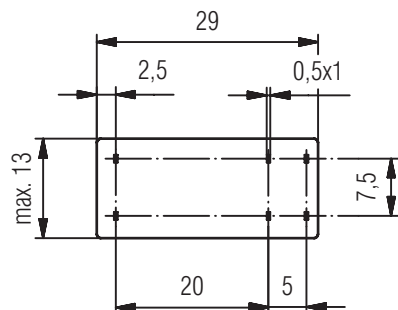
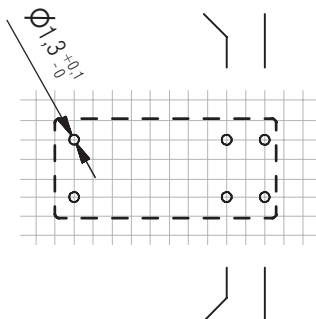

M2059_d
OA5668.02
OW5668.02

OA5669.02
OW5669.02

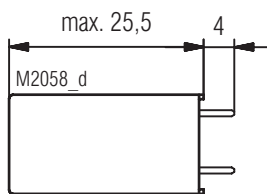
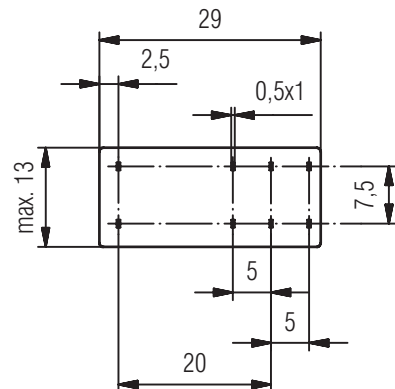
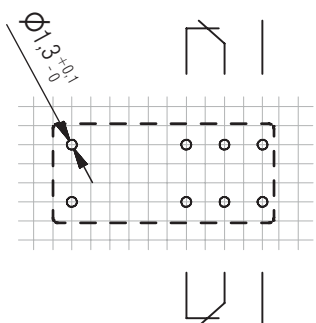

M2058_d
OA5668.12
OW5668.12

OA5669.12
OW5669.12

Connection for basic grid dimensions 2.5 mm as well as 2.54 mm according to IEC/EN 60097 and IEC 60326 average

Relay socket incl. fixing clip

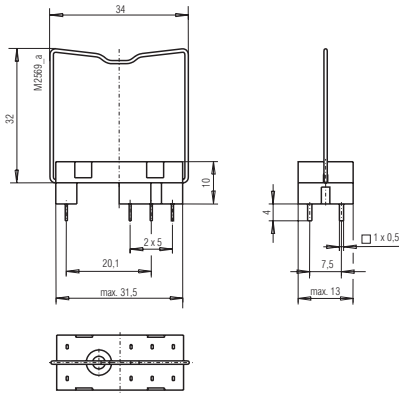

Relay socket ET 1415.021 Fixing clip ET 1415.025

Article number:: 0034769

Fixing clip (wire):
Article number: 0034770

Fixing clip (plastic):
Article number: 0047726

Packing: 100 pieces

Function modules

ET1415.913:	DC 24 V, with free-wheel diode and green LED
Article number:	0056828
ET1415.911:	DC 24 V, with free-wheel diode and red LED
Article number:	0055909
ET1415.912:	AC/DC 24 V, with varistor and green LED
Article number:	0055910
ET1415.924:	DC 60 V, with free-wheel diode and red LED
Article number:	0062552
Packing:	20 pieces

Socket ET 1415.041 incl. fixing clip - Screw terminals -

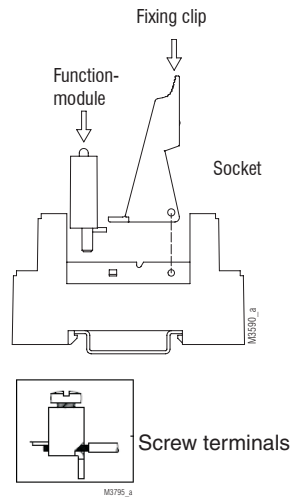

Article number:: 0055571

Temperature range: - 25 ... + 70 °C

Clearance and creepage distance

Rated impulse voltage /
degree of protection

Input / output: 6 kV / 2 IEC 60664-1

Output / output: 4 kV / 2 IEC 60664-1

Overvoltage category: III

Degree of protection: IP 20 IEC/EN 60529

Wire connection

Solid / stranded: 0.5 - 2.5 mm² (20-14 AWG)

Sleeved end: 0.14 - 2.5 mm² (26-14 AWG)

Stripping length 7 mm

Wire fixing: Screw terminals

Fixing torque: Max. 0.8 Nm

Mounting: DIN-rail IEC/EN 60715

Weight: Approx. 38.5 g

Packing: 10 pieces

Dimensions

Width x height x depth: 15.8 x 75 x 69.0 mm

Socet ET 1415.044 incl. fixing clip - Screw terminals -

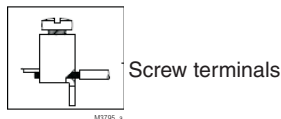
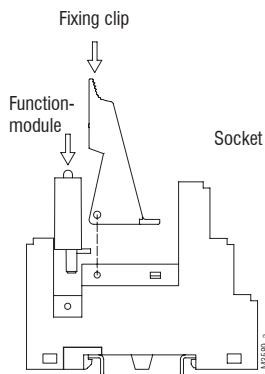

- Incl. safe separation between coil and contacts according to DIN EN 60947-1, DIN EN 61140

Article number: 0059274

Temperature range: - 25 ... + 70 °C
Clearance and creepage distance
 Rated impulse voltage / degree of protection
 Input / output: 6 kV / 2 IEC 60664-1
 Output / output: 4 kV / 2 IEC 60664-1
 Overvoltage category: III
Degree of protection: IP 20 IEC/EN 60529
Wire connection
 Solid / stranded: 0.5 - 2.5 mm² (20-14 AWG)
 Sleeved end: 0.14 - 2.5 mm² (26-14 AWG)
Stripping length 7 mm
Wire fixing: Screw terminals
Fixing torque: Max. 0.8 Nm
Mounting: DIN-rail IEC/EN 60715
Weight: Approx. 43.5 g
Packing: 10 pieces

Dimensions

Width x height x depth: 15.8 x 75 x 75.0 mm

Socet ET 1415.047 incl. fixing clip - Cage clamp terminals -

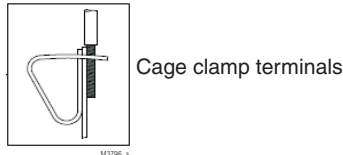
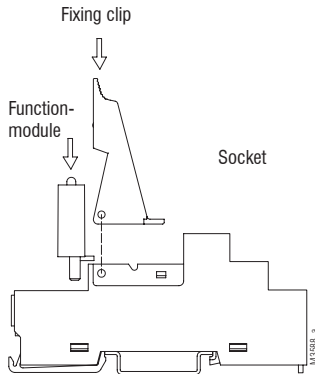

Article number: 0059270

Temperature range: - 25 ... + 70 °C
Clearance and creepage distance
 Rated impulse voltage / degree of protection
 Input / output: 6 kV / 2 IEC 60664-1
 Output / output: 4 kV / 2 IEC 60664-1
 Overvoltage category: III
Degree of protection: IP 20 IEC/EN 60529
Wire connection
 2 x Solid / stranded: 0,5 - 1,5 mm² (20-16 AWG)
 2 x Sleeved end: 0,14 - 1,5 mm² (26-16 AWG)
Stripping length 11 mm
Wire fixing: Cage clamp terminals
Mounting: DIN-rail IEC/EN 60715
Weight: Approx. 42.0 g
Packing: 10 pieces

Dimensions

Width x height x depth: 15.8 x 97 x 75.5 mm

