

Gold plated double contacts
see separate datasheet

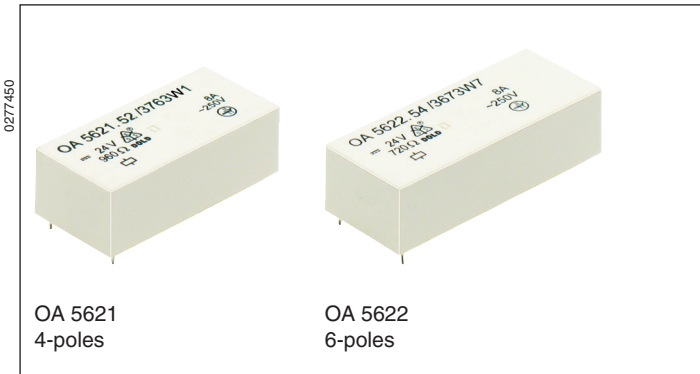

- According to DIN EN 61810-1, DIN EN 61810-3 (Type A)
- With forcibly guided contacts
- Clearance and creepage distances:
Contact - contact ≥ 5.5 mm
- Low rated power consumption and holding power
- High mechanical service life
- High temperature range
- High thermal continuous current
- 15.5 mm height
- Version with double contacts possible, AgNi + 5 μ m Au-contacts

Applications

- To be used in electrical circuits for safety applications
- Escalators and walkways
- Elevators for men and load
- Press controls
- Railway technology
- Medical technology

Approvals and Markings



Technical Data

Relay type	OA 5621	OA 5622	OA 5622.50
1.0 Coil			
1.1 Nominal voltage	DC 6, 12, 24, 48, 60, 110 V (others on request)		
1.2 Nominal consumption	0.6 W	0.8 W	0.9 W
1.11 Voltage range	0.75 ... 1.4 U _N		
1.12 Thermal resistance	55 K/W (mounting distance between relays ≥ 5 mm)		
1.13 Holding Power (at 0.5 x U _N)	0.15 W	0.2 W	0.225 W
2.0 Contacts			
2.1 Contact arrangement (Type A)	2 NO / 2 NC 3 NO / 1 NC	3 NO / 3 NC 4 NO / 2 NC 5 NO / 1 NC	2 NO / 4 NC
2.2 Contact material	AgSnO ₂ + 0.2 μ m Au; AgNi + 0.2 μ m Au, AgNi + 5 μ m Au		
2.3 Rated insulation voltage	AC 250 V		
Switching voltage min./max	AC/DC 10 V / DC 250 V, AC 400 V (AC/DC 2 V / 60 V) ¹⁾		
2.4 Limiting continuous current I _{th}	3 x 8 A	5 x 8 A (s. operating voltage limit curve.)	
Switching current min./max	10 mA ⁴⁾ / 8 A (2 mA / 0.3 A) ¹⁾		
2.5 Switching power min./max.	0.1 ⁴⁾ VA / 2000 VA (10 mVA / 12 VA) ¹⁾		
Switching power min./max.	0.1 W ⁴⁾ / 200 W (10 mW / 12 W) ¹⁾ (see limit curve for arc-free operation)		
2.6 Switching capacity to IEC/EN 60947-5-1			
AC 15 ⁷⁾	NO: AC 250 V / 3 A	NC: AC 250 V / 2 A	
AC 15 ⁶⁾	NO: AC 250 V / 5 A	NC: AC 250 V / 2 A	
DC 13 ⁷⁾	NO: DC 24 V / 2 A	NC: DC 24 V / 2 A	
DC 13 ⁷⁾ at 0.1 Hz	NO: DC 24 V / 4 A	NC: DC 24 V / 4 A	
to UL 508	B300 / R300		
2.7 Electrical life	At 1 s On, 1 s Off (see contacts service life)		
at AC 230 V, 5 A, cos ϕ = 1	> 3 x 10 ⁵ switch. cycl. AgSnO ₂	> 2.2 x 10 ⁵ switching cycles AgNi	
at AC 230 V, 8 A, cos ϕ = 1	> 1.5 x 10 ⁵ switch. cycl. AgSnO ₂	> 10 ⁵ switching cycles AgNi	
at DC 24 V, 5 A ohmic	> 2 x 10 ⁵ switch. cycl. AgSnO ₂	> 1.5 x 10 ⁵ switching cycles AgNi	
at DC 24 V, 8 A ohmic	> 10 ⁵ switch. cycl. AgSnO ₂	> 0.75 x 10 ⁵ switching cycles AgNi	
2.8 Switching frequency max	10 switching cycles/s		
2.9 Response time / Release time	Typically 12 ms / Typically 8 ms		
2.10 Contact force	≥ 8 cN		
2.14 Contact gap	> 0.5 mm ⁵⁾		
3.0 Other			
3.1 Mechanical life	> 20 x 10 ⁶ switching cycles		
3.2 Temperature range	- 40 ... + 80 °C		
3.3 Degree of protection, housing	Wash proof RT III		
3.4 Test procedure	A (group mounting)		
3.5 Vibration resistance			
3.6 Climate resistance	40 / 080 / 04; A / B / D IEC/EN 60068-1		
3.7 Short circuit strength 1 kA / AC 250 V	AgSnO ₂ NO: 10 A gG / gL / NC: 10 A gG / gL	IEC/EN 60947-5-1	
	AgNi NO: 10 A gG / gL / NC: 6 A gG / gL	IEC/EN 60947-5-1	
3.8 Insulation acc. to IEC 60664-1, EN 50178			

¹⁾ Values for AgNi-contacts + 5 μ m Au ²⁾ At T_u = 60 °C > 10⁵
⁵⁾ Over entire service life acc. to DIN EN 61810-3

³⁾ At T_u = 60 °C > 0.75 x 10⁵ ⁴⁾ Typical values
⁶⁾ Values for AgSnO₂-contacts ⁷⁾ Values for AgNi-contacts

Technical Data

Rated insulation voltage	AC 250 V		
Pollution degree	2		
Overvoltage category	III		
Test voltage			
Contact-coil (1 min)	≥ AC 4 kV eff.		
Contact-contact (1min)	≥ AC 4 kV eff.		
Contact open (1 min)	≥ AC 1.5 kV eff.		
Transient voltage			
Contact-coil (1,2 - 50 µs)	≥ 6 kV		
Clearance and creepage distance	≥ 5.5 mm		
3.9 Weight	Approx. 35 g	Approx. 38 g	Approx. 38 g
4.0 Packing unit			
4.1 On cardboard in slipcase	25 pieces	20 pieces	20 pieces
4.2 In case package	250 pieces	200 pieces	200 pieces
5.0 Solder method			
5.1 Solder method /-temperature /-duration	Wave soldering / 260 °C / 5 s		

Design Versions

U _N (DC V)	Voltage range (DC V)	OA 5621			OA 5622					
		R _{Coil} Ω ± 10%	.48 3NO, 1NC	.52 2NO, 2NC	R _{Coil} Ω ± 10%	.18 3NO, 3NC	.54 4NO, 2NC	.60 5NO, 1NC	R _{Coil} Ω ± 10%	.50 2NO, 4NC
AgSnO ₂ -contacts + 0,2 µm Au										
6	4.5 ... 8.4	60	3721	3751	45	3601	3661	3691	38	3631
12	9.0 ... 16.8	240	3722	3752	180	3602	3662	3692	150	3632
24	18.0 ... 33.6	960	3723	3753	720	3603	3663	3693	600	3633
48	36.0 ... 67.2	3840	3724	3754	2880	3604	3664	3694	2425	3634
60	45.0 ... 84.0	6000	3725	3755	4500	3605	3665	3695	3790	3635
110	82.5 ... 154.0	20000	3726	3756	15125	3606	3666	3696	12735	3636
AgNi-contacts + 0,2 µm Au										
6	4.5 ... 8.4	60	3731	3761	45	3611	3671	3701	38	3641
12	9.0 ... 16.8	240	3732	3762	180	3612	3672	3702	150	3642
24	18.0 ... 33.6	960	3733	3763	720	3613	3673	3703	600	3643
48	36.0 ... 67.2	3840	3734	3764	2880	3614	3674	3704	2425	3644
60	45.0 ... 84.0	6000	3735	3765	4500	3615	3675	3705	3790	3645
110	82.5 ... 154.0	20000	3736	3766	15125	3616	3676	3706	12735	3646
AgNi-contacts + 5 µm Au										
6	4.5 ... 8.4	60	3741	3771	45	3621	3681	3711	38	3651
12	9.0 ... 16.8	240	3742	3772	180	3622	3682	3712	150	3652
24	18.0 ... 33.6	960	3743	3773	720	3623	3683	3713	600	3653
48	36.0 ... 67.2	3840	3744	3774	2880	3624	3684	3714	2425	3654
60	45.0 ... 84.0	6000	3745	3775	4500	3625	3685	3715	3790	3655
110	82.5 ... 154.0	20000	3746	3776	15125	3626	3686	3716	12735	3656

Ordering Example

OA 5622 / / 61*)

- Pin configuration
- W = Wash proof RT III
- Design version
- Contact arrangement (Type A)
 - .50 2 NO, 4 NC
 - .18 3 NO, 3 NC
 - .54 4 NO, 2 NC
 - .60 5 NO, 1 NC
- Type

Notes

For the use and processing of our PCB relays, please refer to the **application and processing instructions** at www.dold.com

*) / 61 cURus approval

On request version with double contacts

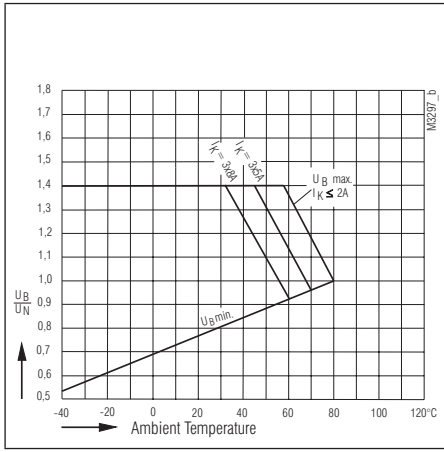

Operating voltage limit curve OA 5621

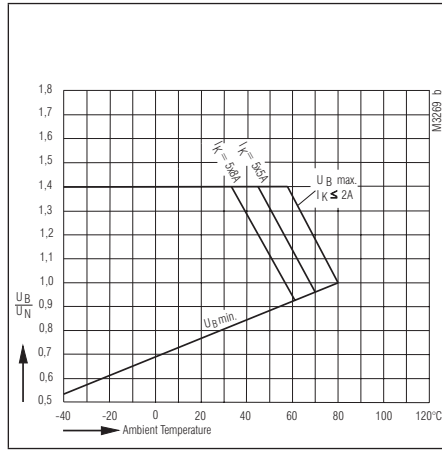

Operating voltage limit curve OA 5622

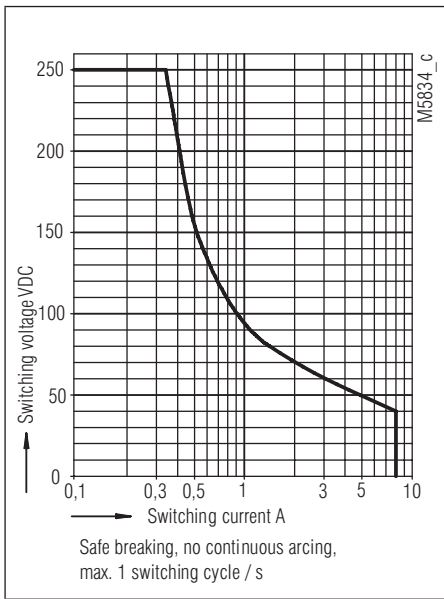

Arc limit curve (load limit curve)

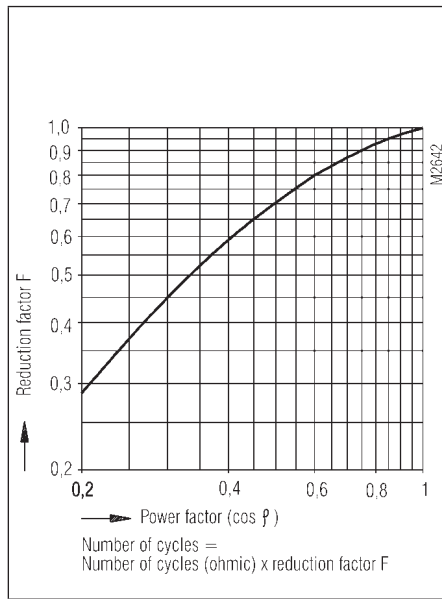

Reduction factor for inductive loads

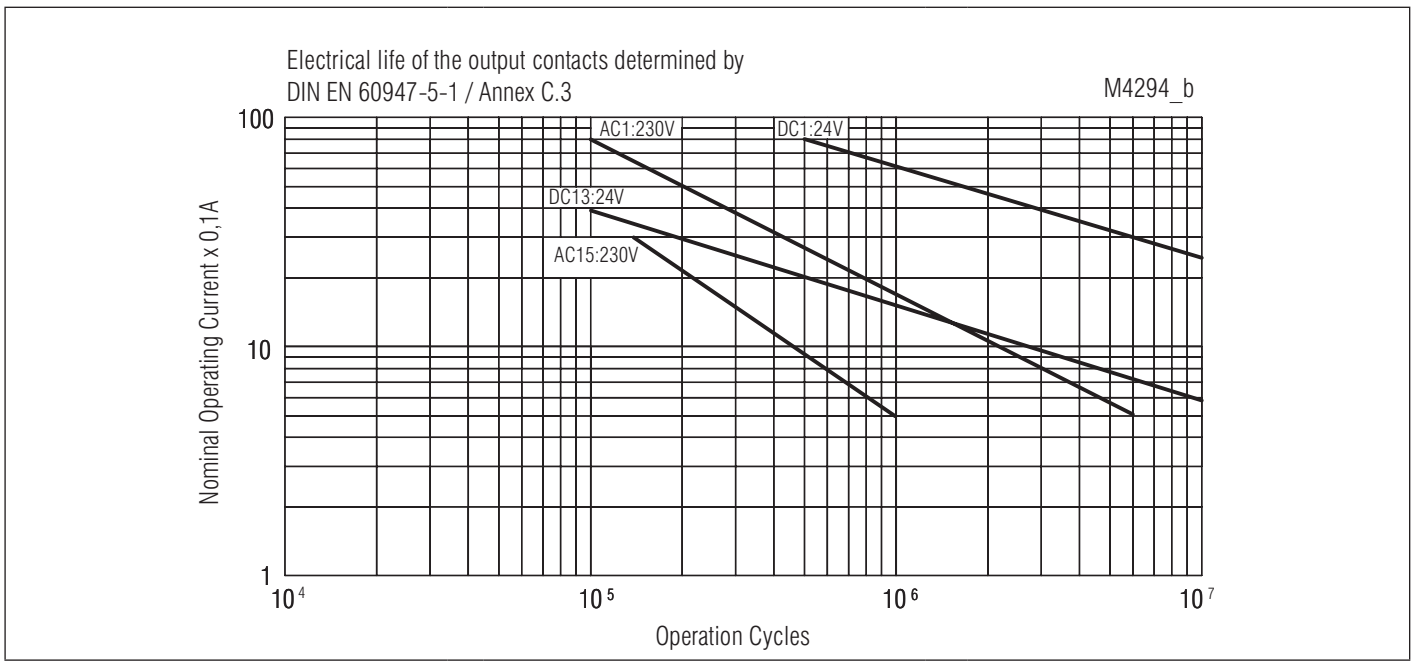

Pin Configuration W1 / W5

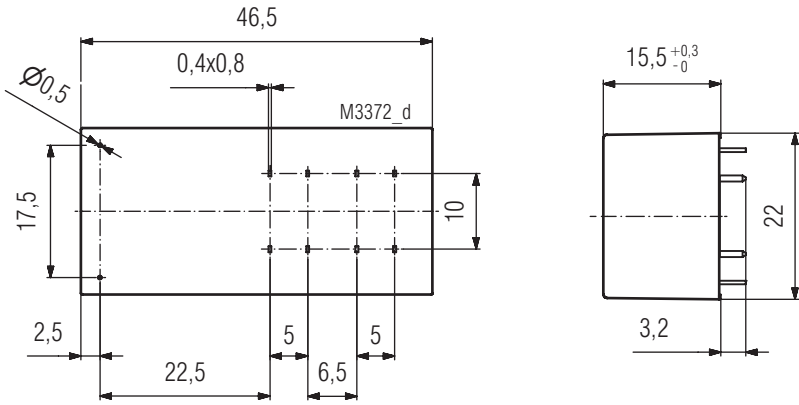

Pin Configuration sW1
Drilling plan (solder side)

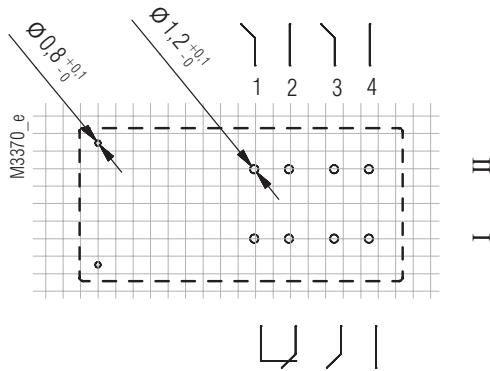

OA5621.48/___W1 3NO / 1NC

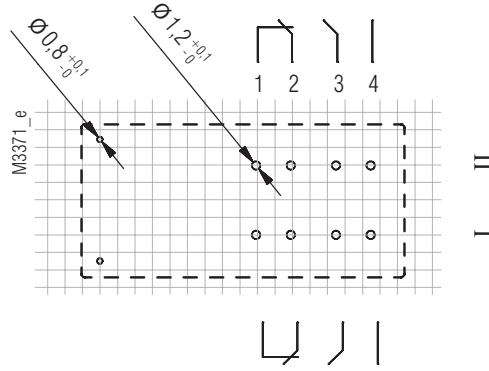

OA5621.52/___W1 2NO / 2NC

Pin Configuration D5
Drilling plan (solder side)

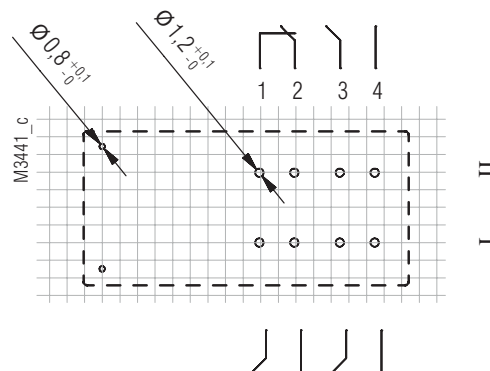

OA5621.48/___W5 3NO / 1NC

Connection for basic grid dimensions 2.50 mm as well as 2.54 mm according to IEC/EN 60 097, IEC 60 326

Pin Configuration W7

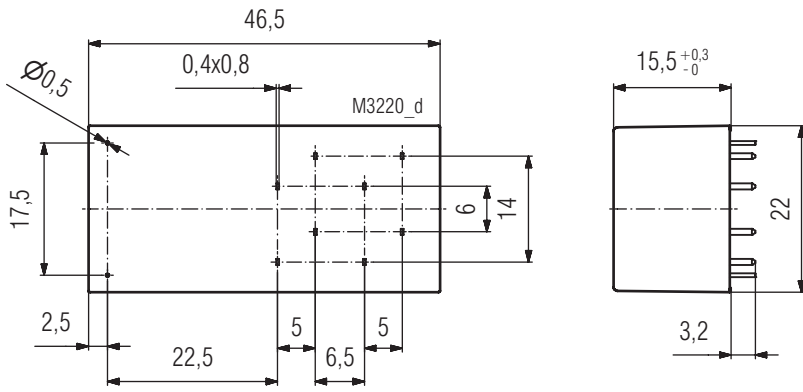

Pin Configurations W7
Drilling plan (solder side)

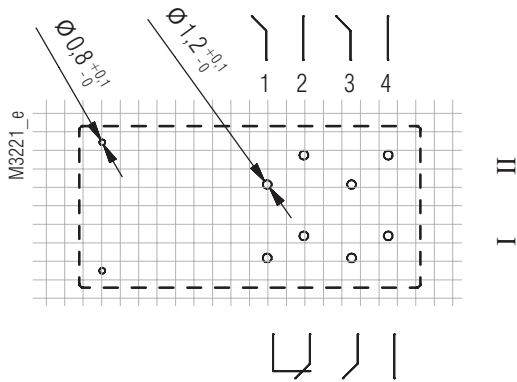

OA5621.48/___W7 3NO / 1NC

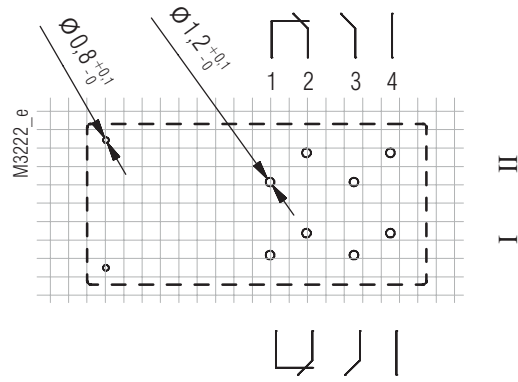

OA5621.52/___W7 2NO / 2NC

Connection for basic grid dimensions 2.50 mm as well as 2.54 mm according to IEC/EN 60 097, IEC 60 326

Pin Configuration W1

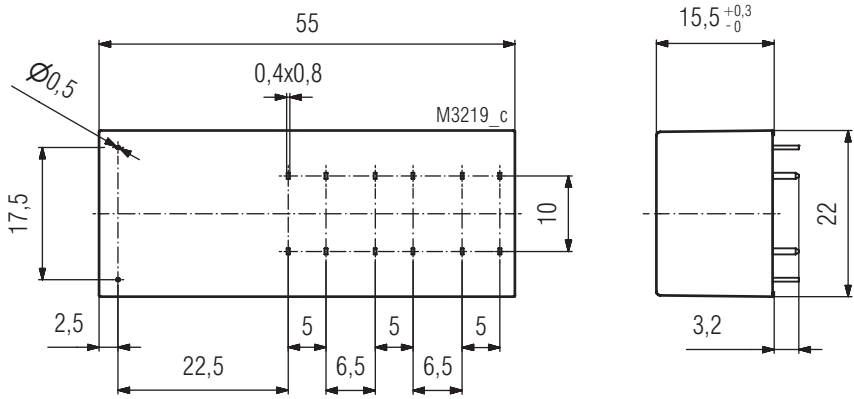

Pin Configurations W1
Drilling plan (solder side)

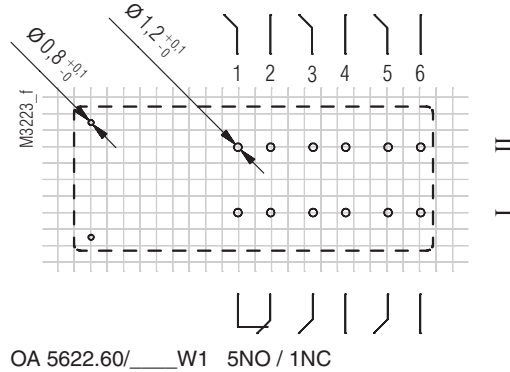
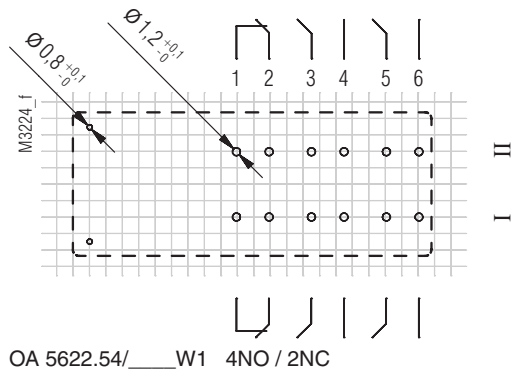
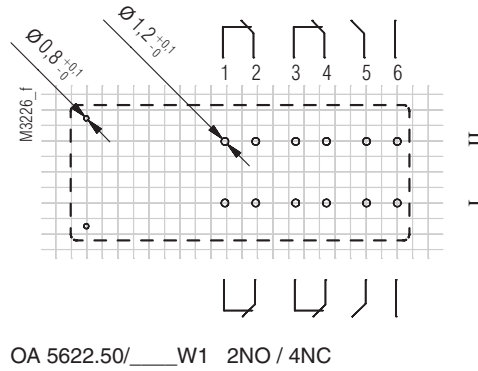
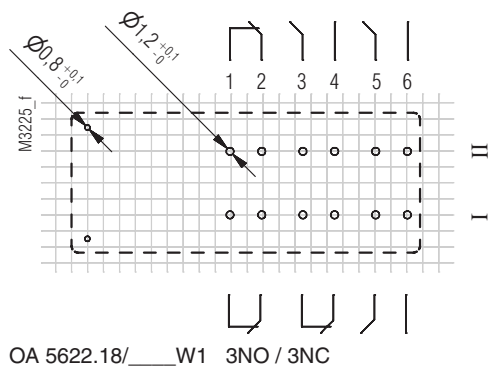

Pin Configuration W5
Drilling plan (solder side)

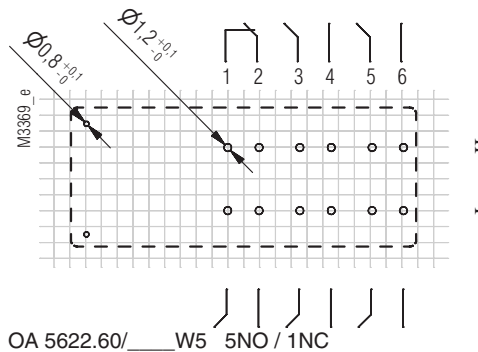

Connection for basic grid divisions 2.50 mm as well as 2.54 mm according to IEC/EN 60 097, IEC 60 326

Pin Configuration W7

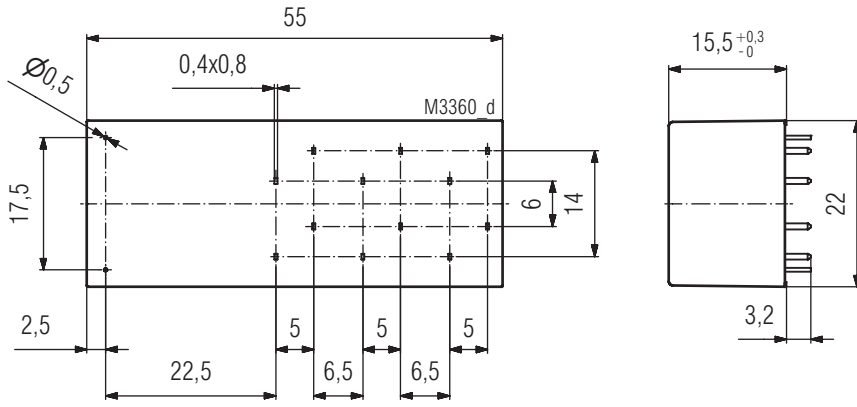

Pin Configurations W7
Drilling plan (solder side)

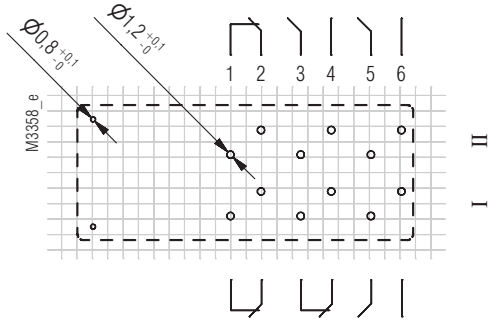

OA 5622.18/___W7 3NO / 3NC

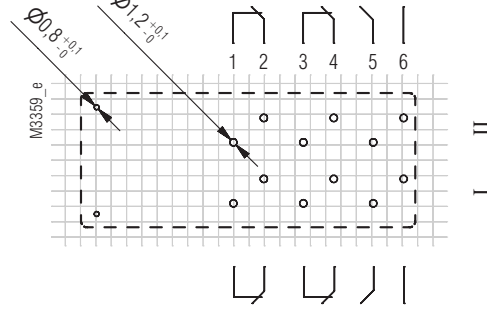

OA 5622.50/___W7 2NO / 4NC

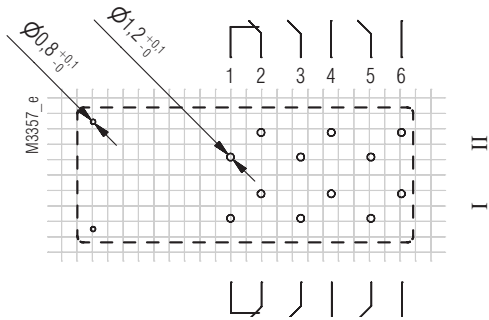

OA 5622.54/___W7 4NO / 2NC

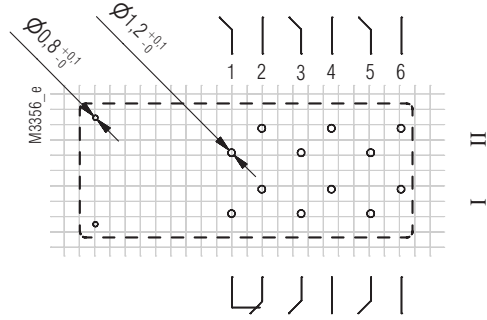

OA 5622.60/___W7 5NO / 1NC

Pin Configurations W8
Drilling plan (solder side)

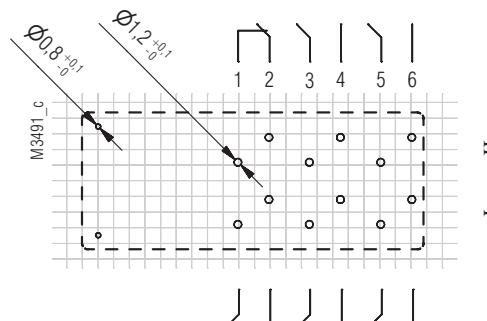

OA 5622.60/___W8 5NO / 1NC

Connection for basic grid dimensions 2.50 mm as well as 2.54 mm according to IEC/EN 60 097, IEC 60 326

Notes

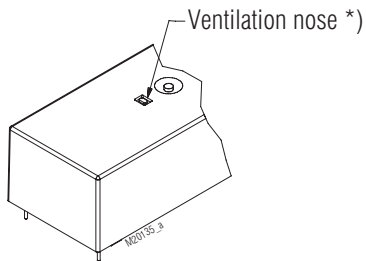

*) When using the maximum switching capacity it is recommended to open the relay at the indicated position.

Accessories

Relay socket ET 1415.035 for OA 5621

Article number: 0059509

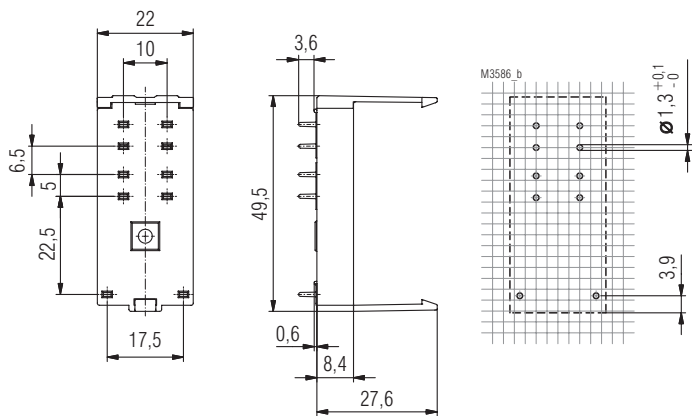

Relay socket ET 1415.037 for OA 5622

Article number: 0059275

