

EAC



Kz - Kazakhstan

INPUT: 500A... 2000A

5A

OUTPUT: 1A

1A

DATI TECNICI - Technical data

custodia in materiale termoplastico autoestinguente	self extinguishing thermoplastic material	UL94-V0
frequenza funzionamento	operating frequency	50÷60 Hz
tensione di riferimento per l'isolamento	insulation reference voltage	0,72 kV
tensione di prova	test voltage	3 kV x 1' 50 Hz
isolamento	insulation	classe E
grado di protezione	protection degree	IP 20
sovracorrente permanente	continuous overcurrent	100% In
corrente termica di breve durata nominale (I th)	rated short-time thermal current (I th)	60 In
corrente dinamica nominale (I dyn)	rated dynamic current (I dyn)	2,5 x I th
max. potenza dissipata (portata max.)	max. power dissipation (max range value)	≤10W
temperatura di funzionamento	operating temperature	-25 +50 °C
temperatura di magazzino	storage temperature	-40 +80 °C
costruzione a norme	manufactured according to	IEC/EN 61869-1 IEC/EN 61869-2
terminali secondari integrati	integrated secondary terminals	6mm ²

TIPO - Type

DIMENSIONI - Dimensions

Rapporto Ratio	Codice - Code			
	VA	Cl. 0,2	VA	Cl. 0,5S
500/5A	3	TAT061500J05	3	TAT061500Y05
600/5A	4	TAT061600J05	4	TAT061600Y05
800/5A	6	TAT061800J05	6	TAT061800Y05
1000/5A	10	TAT0611K0J05	10	TAT0611K0Y05
1200/5A	12	TAT0611K2J05	12	TAT0611K2Y05
1500/5A	20	TAT0611K5J05	20	TAT0611K5Y05
2000/5A	25	TAT0612K0J05	25	TAT0612K0Y05

Sono disponibili i trasformatori con secondario 1A e pari prestazioni, i codici di ordinazione sono come in tabella ma con ultima cifra 1

CTs at 1A secondary current are also available. The burdens are the same as 5A CTs. The ordering codes are the same as those in the above table but the last figure shall be 1 instead of 5.

Esempio / Example

TA.....05 (secondario/secondary 5A) TA.....01 (secondario/secondary 1A)



Siglatura morsetti primario e secondario
Primary and secondary connections marking

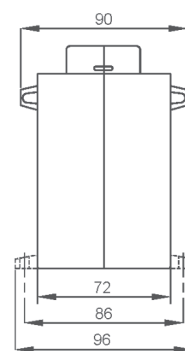
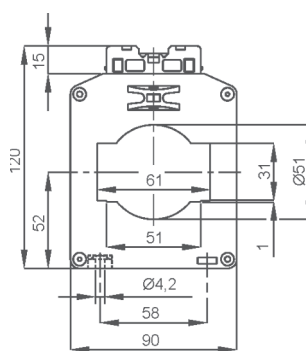

Tipo con passaggio barra orizzontale
Codici ordinazione come in tabella

Horizontal busbar passing type
same ordering codes as shown in table

kg 0,70 ...1,40

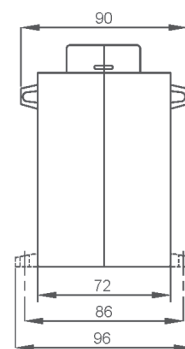
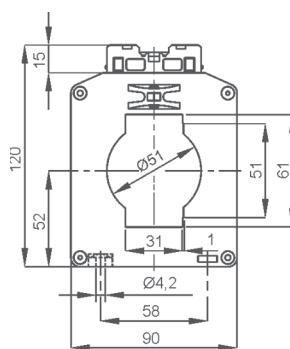

Tipo con passaggio barra verticale
Codici ordinazione come in tabella ma con finale V

Vertical busbar passing type
same ordering codes as shown in table with V at the end

kg 0,70 ...1,40

NOTE - Note

ACCESSORI IN DOTAZIONE
- viti per fissaggio TA alla barra
- cappuccio di protezione per vite fissaggio

SUPPLIED ACCESSORY
- CT fixing set for busbar mounting
- protective caps for CT fixing

OPZIONI - OPTIONS

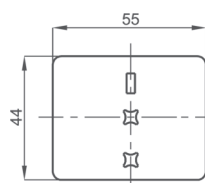

Coprimorsetti sigillabile cod. 9SBMCTA
Sealable terminals cover cod. 9SBMCTA

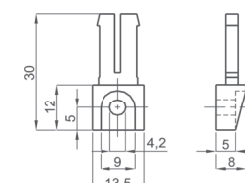
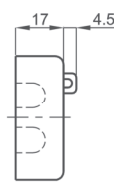

Piedini di fissaggio cod. 9SAMPDC
Fixing feet cod. 9SAMPDC