



Pressure transmitter

Huba Control

Relative pressure transmitter Type 525



The pressure transmitter type 525 has a compact and robust design and a very high measurement accuracy. The pressure transmitter with its large variety of pressure and electrical connection has also pressure ranges from 50 mbar full scale.

The compact 525 pressure transmitter is based upon the well proven ceramic technology developed by Huba Control over 20 years ago.

Pressure range
0 ... 0.05 – 0.6 bar

- + Very high measurement accuracy
- + Excellent thermal characteristic
- + Pressure ranges from 50 mbar full scale available
- + Compact and rugged construction
- + Large selection of connections available

Technical overview

Pressure range

Relative 0 ... 0.05 – 0.6 bar

Operating conditions

Medium			Liquids and gases
Temperature	Medium	FPM	-15 ... +85 °C
		EPDM	-25 ... +85 °C
		NBR	-20 ... +85 °C
	Ambient	-25 ... +85 °C	
	Storage	-40 ... +85 °C	
Tolerable overload / rupture pressure			2 bar
Tolerable negative pressure			-0.3 bar

Materials

Plug accommodation		Polyarylamide 50% GF UL 94 V-0
Materials in contact with medium	pressure connection	Stainless steel 1.4404 / AISI 316L
	measuring element	Ceramics Al ₂ O ₃ (99.6%)
	sealing material	FPM, EPDM, NBR

Electrical overview

2 wire	Output	Power supply	Load	Current consumption
	4 ... 20 mA	10 ... 30 VDC	$< \frac{\text{supply voltage} - 10 \text{ V}}{0.02 \text{ A}}$ [Ohm]	< 23 mA
3 wire	0 ... 5 V	7 ... 33 VDC	>10 kOhm / < 100 nF	< 5 mA
	0 ... 10 V	12 ... 33 VDC	>10 kOhm / < 100 nF	< 5 mA
	ration. 10 ... 90%	5 VDC ± 10%	>10 kOhm / < 100 nF	< 5 mA
Polarity reversal protection	Short circuit proof and protected against polarity reversal. Each connection is protected against crossover up to max. supply voltage.			
Insulation voltage	500 VDC			

Dynamic response

Start-up time	< 200 ms
Response time	< 150 ms
Load cycle	< 100 Hz

Electrical connection

Electrical connection	Protection standard	Protection class
Connector DIN EN 175301-803-A	IP 65	III
Connector DIN EN 175301-803-C (Industrial standard 9.4 mm)	IP 65	III
Connector M12x1	IP 67	III
Swift connector without or with cable 1.5 / 2 / 3 / 5 m (PVC spez.)	IP 67	III

Pressure connection

Inside thread	G ¼	with Profile seal ring in FPM
	¼ -18 NPT	
Outside thread	R ¼	nach EN 10226
	G ⅝	sealed at front
	G ⅝	sealed at back DIN EN ISO 1179-2-E with Profile seal ring in FPM
	G ¼	sealed at front
	G ¼	sealed at back DIN EN ISO 1179-2-E with Profile seal ring in FPM
	G ½	sealed at front
	G ½	sealed at back DIN EN ISO 1179-2-E with Profile seal ring in FPM, with hole Ø11 mm

Installation arrangement

Unrestricted (Note the position error!)

Tests / Admissions

Electromagnetic compatibility	CE conformity acc. EN 61326-2-3
Shock acc. IEC 68-2-27	50 g, 6 ms half sine wave, all 6 directions, free fall from 1 m on concrete (6x)
Vibration nach IEC 68-2-6	20 g, 15 ... 2000 Hz, 15 ... 25 Hz with amplitude ± 15 mm, 1 Octave/min. all 3 directions, 50 constant load
UL	ANSI/UL 61010-1 acc. E325110
EAC	
Protection against explosion 	Ex II ½ G Ex ia IIC T4 Ga/Gb
(4 ... 20 mA) acc. ATEX and IECEx	Ex II ½ D Ex ia IIIC T120°C Da/Db

Weight

~ 120 g

Packaging (Please state on order)

Single packaging in cardboard	accessories integrated
Multiple packaging in cardboard (25 pcs)	

Accuracy

Parameter	Unit	
Characteristic line ¹⁾ (bei 25 °C)	% fs	± 0.35 ²⁾
Resolution	% fs	< 0.1
Long term stability acc. IEC EN 60770-1	% fs	± 0.25
Thermal characteristic ³⁾	% fs/10K	± 0.07
Location error horizontal mounting	mbar	+ 0.1
Location error vertical mounting, pressure connection upward	mbar	+ 0.2

Test conditions: 45% rH, power supply 24 VDC
Balance position: Vertical, pressure connection down

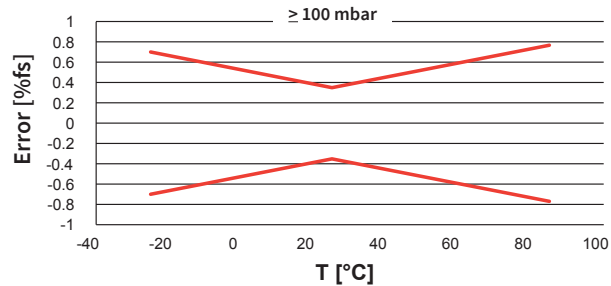
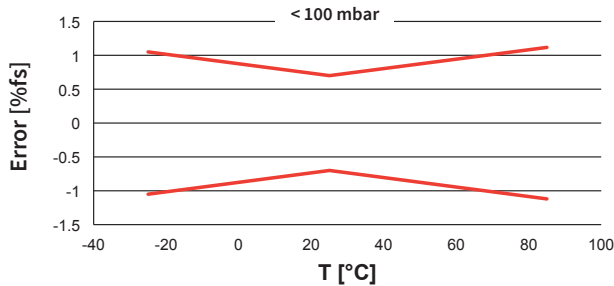

Order code selection table in bar		1	2	3	4	5	6	7	8	9	10	11	
		525.	X	X	X	X	X	X	X	X	X	X	
Pressure range ⁴⁾	0 ... 0.05 bar	9	2	1									
	0 ... 0.10 bar	9	2	2									
	0 ... 0.16 bar	9	2	3									
	0 ... 0.20 bar	9	2	4									
	0 ... 0.25 bar	9	2	5									
	0 ... 0.30 bar	9	2	6									
	0 ... 0.40 bar	9	2	7									
	0 ... 0.60 bar	9	2	8									
Sealing material	FPM Fluoro elastomer				0	0							
	EPDM Ethylene propylene				1	0							
	NBR Butadiene Acrylonitrile				2	0							
Output / power supply	0 ... 5V 7 ... 33 VDC							1					
	0 ... 10V 12 ... 33 VDC							2					
	4 ... 20 mA 10 ... 30 VDC							3					
	10 ... 30 VDC ⁶⁾							4					
	ration. 10 ... 90% 5VDC ±10%							7					
Electical connection	Connector ⁵⁾	DIN EN 175301-803-A							1				
		DIN EN 175301-803-C (industrial standard 9.4 mm)							2				
		M12x1 2w: IN=1 / OUT=3 3w: IN=1 / OUT=4 / GND=3							3				
		M12x1 3w: IN=1 / OUT=3 / GND=4							1,2	M			
		M12x1 2w: IN=1 / OUT=2 3w: IN=1 / OUT=2 / GND=3								P			
	Swift connector	without cable (PG9)								0			
		with cable 1.5 m								L			
		with cable 2.0 m								N			
		with cable 3.0 m								Q			
		with cable 5.0 m								R			
Pressure connection ⁴⁾	Inside thread	G ¼ with O-Ring seal FPM								1	1	1	
		¼ -18 NPT								3	1	1	
		R ¼ acc. to EN 10226									7	1	1
		G ½ sealed at front									M	1	1
		G ½ sealed at back DIN EN ISO 1179-2-E with Profile seal ring in FPM									H	1	1
	Outside thread	G ¼ sealed at front									J	1	1
		G ¼ sealed at back DIN EN ISO 1179-2-E with Profile seal ring in FPM									4	1	1
		G ½ sealed at front									9	1	1
		G ½ sealed at back DIN EN ISO 1179-2-E with Profile seal ring in FPM									8	1	1
		G ½ sealed at back DIN EN ISO 1179-2-E with Profile seal ring in FPM with hole Ø 11mm									S	1	1
Pressure range variation (optional)	Indicate W and state range on order (e. g. W0... + 0.5bar/OUT0.5...4.5V)											W	

¹⁾ incl. zero point, full scale, linearity, hysteresis and repeatability

²⁾ fs <100 mbar ±0.7% fs

³⁾ Zero point and span for range -25...+85 °C, possible deviation of difference between Tmedia/Tambient

⁴⁾ Other pressure ranges on request

⁵⁾ Delivery without female connector

		1	2	3	4	5	6	7	8	9	10	11	
Order code selection in psi		525.	X	X	X	X	X	X	X	X	X	X	
Pressure range ¹⁾	0 ... 1 psi	9	B	1									
	0 ... 2 psi	9	B	2									
	0 ... 3 psi	9	B	4									
	0 ... 5 psi	9	B	6									
	0 ... 10 psi	9	B	8									
Sealing material	FPM	Fluoro elastomer				0	0						
	EPDM	Ethylene propylene				1	0						
	NBR	Butadiene Acrylonitrile				2	0						
Output / power supply	0 ... 5 V	7 ... 33 VDC						1					
	0 ... 10 V	12 ... 33 VDC						2					
	4 ... 20 mA	10 ... 30 VDC						3					
		10 ... 30 VDC 						4					
	ration. 10 ... 90%	5VDC ±10%						7					
Electrical connection	Connector ²⁾	DIN EN 175301-803-A						1					
		DIN EN 175301-803-C (industrial standard 9.4 mm)						2					
		M12x1	2w: IN=1 / OUT=3	3w: IN=1 / OUT=4 / GND=3					3				
		M12x1		3w: IN=1 / OUT=3 / GND=4				1,2	M				
	Swift connector	M12x1	2w: IN=1 / OUT=2	3w: IN=1 / OUT=2 / GND=3					P				
		without cable							0				
		with cable 1.5 m								L			
		with cable 2.0 m								N			
		with cable 3.0 m								Q			
		with cable 5.0 m								R			
Pressure connection ¹⁾	Inside thread	G ¼ with O-Ring seal FPM							1	1	1		
		¼ -18 NPT							3	1	1		
	Outside thread	R ¼ acc. to EN 10226							7	1	1		
		G ½ sealed at front							M	1	1		
		G ½ sealed at back DIN EN ISO 1179-2-E with Profile seal ring in FPM							H	1	1		
		G ¼ sealed at front							J	1	1		
		G ¼ sealed at back DIN EN ISO 1179-2-E with Profile seal ring in FPM							4	1	1		
		G ½ sealed at front							9	1	1		
		G ½ sealed at back DIN EN ISO 1179-2-E with Profile seal ring in FPM							8	1	1		
		G ½ sealed at back DIN EN ISO 1179-2-E with Profile seal ring in FPM with hole Ø 11mm							S	1	1		
Pressure range variation (optional)	Indicate W and state range on order (e.g.: W0... + 0.5bar/OUT0.5...4.5V)											W	

		1	2	3	4	5	6	7	8	9	10	11	
Order code selection in MPa		525.	X	X	X	X	X	X	X	X	X	X	
Pressure range ¹⁾	0 ... 0.005 MPa	9	G	1									
	0 ... 0.010 MPa	9	G	2									
	0 ... 0.016 MPa	9	G	3									
	0 ... 0.020 MPa	9	G	4									
	0 ... 0.025 MPa	9	G	5									
	0 ... 0.030 MPa	9	G	6									
	0 ... 0.040 MPa	9	G	7									
	0 ... 0.060 MPa	9	G	8									
	Sealing material	FPM	Fluoro elastomer				0	0					
EPDM		Ethylene propylene				1	0						
NBR		Butadiene Acrylonitrile				2	0						
Output / power supply	0 ... 5 V	7 ... 33 VDC						1					
	0 ... 10 V	12 ... 33 VDC						2					
	4 ... 20 mA	10 ... 30 VDC						3					
		10 ... 30 VDC 						4					
	ration. 10 ... 90%	5VDC ±10%						7					
Electrical connection	Connector ²⁾	DIN EN 175301-803-A						1					
		DIN EN 175301-803-C (industrial standard 9.4 mm)						2					
		M12x1	2w: IN=1 / OUT=3	3w: IN=1 / OUT=4 / GND=3					3				
		M12x1		3w: IN=1 / OUT=3 / GND=4				1,2	M				
	Swift connector	M12x1	2w: IN=1 / OUT=2	3w: IN=1 / OUT=2 / GND=3					P				
		without cable (PG9)							0				
		with cable 1.5 m								L			
		with cable 2.0 m								N			
		with cable 3.0 m								Q			
		with cable 5.0 m								R			
Pressure connection ¹⁾	Inside thread	G ¼ with O-Ring seal FPM							1	1	1		
		¼ -18 NPT							3	1	1		
	Outside thread	R ¼ acc. to EN 10226							7	1	1		
		G ½ sealed at front							M	1	1		
		G ½ sealed at back DIN EN ISO 1179-2-E with Profile seal ring in FPM							H	1	1		
		G ¼ sealed at front							J	1	1		
		G ¼ sealed at back DIN EN ISO 1179-2-E with Profile seal ring in FPM							4	1	1		
		G ½ sealed at front							9	1	1		
		G ½ sealed at back DIN EN ISO 1179-2-E with Profile seal ring in FPM							8	1	1		
		G ½ sealed at back DIN EN ISO 1179-2-E with Profile seal ring in FPM with hole Ø 11mm							S	1	1		
Pressure range variation (optional)	Indicate W and state range on order (e.p.: W0... + 0.5bar/OUT0.5...4.5V)											W	

Accessories (supplied loose)	Order number
Female connector DIN EN 175301-803-A with seal	103510
Connector DIN EN 175301-803-C with seal	104244
Corner-wire box for connector M12x1	106975
Calibration certificate	104551

¹⁾ Other pressure ranges on request

²⁾ Delivery without female connector

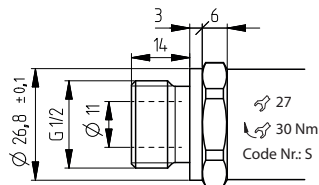
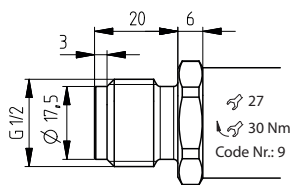
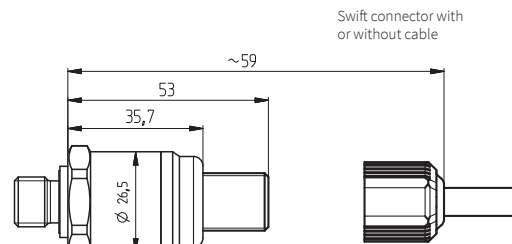
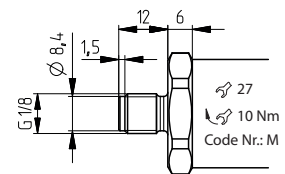
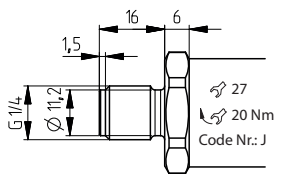
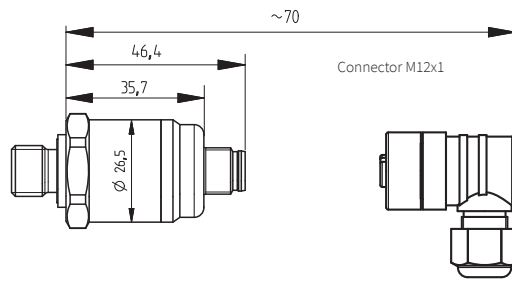
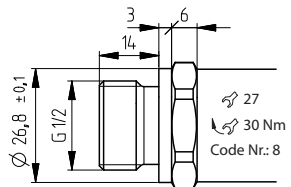
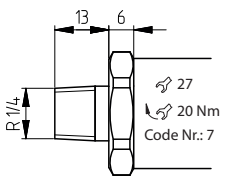
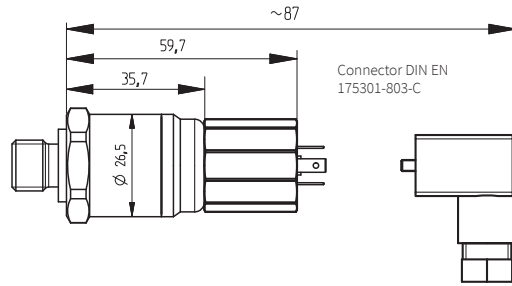
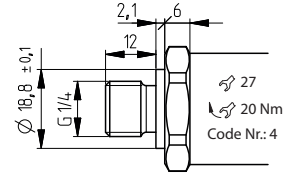
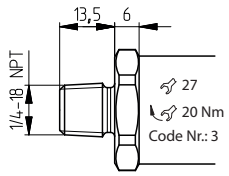
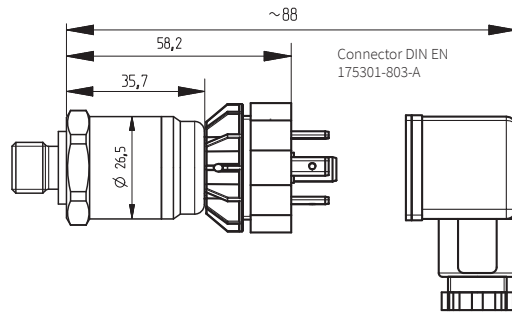
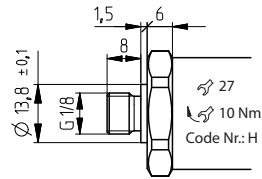
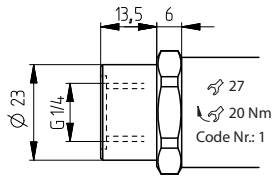

Electrical connections

2 wire

Connector DIN EN
175301-803-A

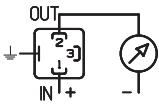

1 (IN) 2 (OUT) ⊥

Connector DIN EN
175301-803-C

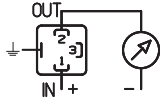

1 (IN) 2 (OUT) ⊥

Connector M12x1

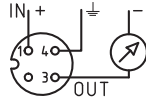

1 (IN) 3 (OUT) ⊥

Connector M12x1

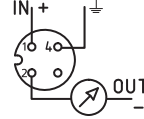

1 (IN) 2 (OUT) 4 (⊥)

Swift connector

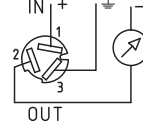

1 (IN) 2 (OUT) 3 (⊥)

3 wire

Connector DIN EN
175301-803-A

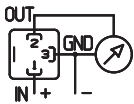

1 (IN) 2 (OUT) 3 (GND)

Connector DIN EN
175301-803-C

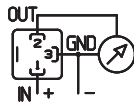

1 (IN) 2 (OUT) 3 (GND)

Connector M12x1

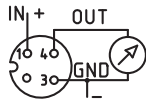

1 (IN) 4 (OUT) 3 (GND)

Connector M12x1

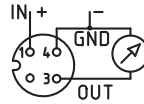

1 (IN) 3 (OUT) 4 (GND)

Connector M12x1

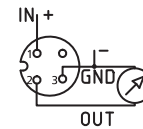

1 (IN) 2 (OUT) 3 (GND)

Swift connector

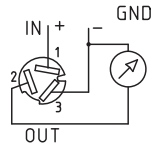

1 (IN) 2 (OUT) 3 (GND)

Grounding for devices

The pressure transmitter must be connected to the equipotential bonding system of the plant via the metal housing (process connection) or the ground conductor of the plug/cable. The grounding connection is conductively connected to the transmitter housing.

Products without ex protection do not need any electrical grounding (no influence on function).

Huba Control AG

Headquarters Schweiz
Industriestrasse 17
CH-5436 Würenlos
Telefon +41 56 436 82 00
Fax +41 56 436 82 82
info.ch@hubacontrol.com

Huba Control AG

Niederlassung Deutschland
Schlattgrabenstrasse 24
D-72141 Walddorfhäslach
Telefon +49 7127 2393 00
Fax +49 7127 2393 20
info.de@hubacontrol.com

Huba Control AG

Vestiging Nederland
Hamseweg 20A
NL-3828 AD-Hoogland
Telefoon +31 33 433 03 66
Telefax +31 33 433 03 77
info.nl@hubacontrol.com

Huba Control SA

Succursale France
Rue Lavoisier
Technopôle Forbach-Sud
F-57602 Forbach Cedex
Téléphone +33 3 87 84 73 00
Télécopieur +33 3 87 84 73 01
info.fr@hubacontrol.com

Huba Control AG

Branch Office United Kingdom
Unit 13 Berkshire House, County Park
Business Centre, Shrivenham Road
Swindon, Wiltshire SN1 2NR
Phone +44 1993 77 66 67
Fax +44 1993 77 66 71
info.uk@hubacontrol.com

www.hubacontrol.com

