

## Merkmale

- mit Federrückzug zur Mittelstellung, beidseitige Betätigung möglich
- Kontakte in Mittelstellung offen, werden bei Betätigung geschlossen
- robustes Metallgehäuse
- Klarsichtdeckel zur optimalen Funktionskontrolle
- bis zu acht Kontakte in fast beliebiger Schaltung (Abwicklung)
- großzügiger Anschlussraum
- geräuscharme Funktionsweise
- einfache Justage durch viele Verstellmöglichkeiten
- zwangsgeführte Öffnerkontakte

## features

- with spring return to center position, actuation from both sides possible
- contacts open in center position, closed when actuated
- robust metal enclosure
- transparent cover for optimal function control
- up to eight contacts in almost any contact arrangement (factory options)
- large connection area
- quiet functioning
- easy adjustment because of many possibilities to position
- positively driven normally closed contacts

## Bestellangaben / order information codes:

		<b>FS - X - YY</b>		
<b>Grundgerät / basic type:</b>	_____		<b>Kontaktabwicklung / contact arrangement:</b>	
<b>FS</b> Feinsteuerschalter mit Mittelstellung leveling limit switch with center position			ohne Angabe without specification	Standardausführung standard version
<b>Anzahl der Kontakte / number of contacts:</b>	_____		<b>YY</b> siehe Schaltwege-Diagramm see contact sequence diagram	
ohne Angabe without specification	2-polig 2-pole			
<b>X</b>	siehe Schaltwege-Diagramm see contact sequence diagram			

**Technische Daten:**

Normen	EN 81-20, EN 81-50, EN 60947-5-1
Schaltleistung	U <sub>i</sub> = 500 V I <sub>th</sub> = 6 A U <sub>imp</sub> = 4 kV
Kurzschlussfestigkeit	AC-15: U <sub>e</sub> = 230 V I <sub>e</sub> = 6 A DC-13: U <sub>e</sub> = 200 V I <sub>e</sub> = 0,3 A
Kontaktwerkstoff	T10 A F 16 A
Betätigungs- / Rückstellkraft	Feinsilber
Anschluss	0,8 N
Schutzart	über Schlitzmutter max. 2,5 mm <sup>2</sup> , Kabeleinführung 2x M20x1,5
Umgebungstemperatur	IP40
Einbaulage	-30 °C bis +80 °C
Gewicht	beliebig
	820 g

**technical data:**

norms	EN 81-20, EN 81-50, EN 60947-5-1
switching capacity	U <sub>i</sub> = 500 V I <sub>th</sub> = 6 A U <sub>imp</sub> = 4 kV
short-circuit capacity	AC-15: U <sub>e</sub> = 230 V I <sub>e</sub> = 6 A DC-13: U <sub>e</sub> = 200 V I <sub>e</sub> = 0.3 A
contact material	T10 A F 16 A
actuation- / return force	fine silver
connection	0.8 N
level of protection	by slot nut max. 2.5 mm <sup>2</sup> , cable entry 2x M20x1.5
ambient air temperature	IP40
installation position	-30 °C up to +80 °C
weight	any
	820 g

**Zubehör / accessories:**

GK-K	Gleitkurve, kurze Ausführung operating ramp, short version
GK-L	Gleitkurve, lange Ausführung operating ramp, long version

Geräteabmessungen / device dimensions:

dargestellt: FS (Standardausführung)  
shown: FS (standard version)

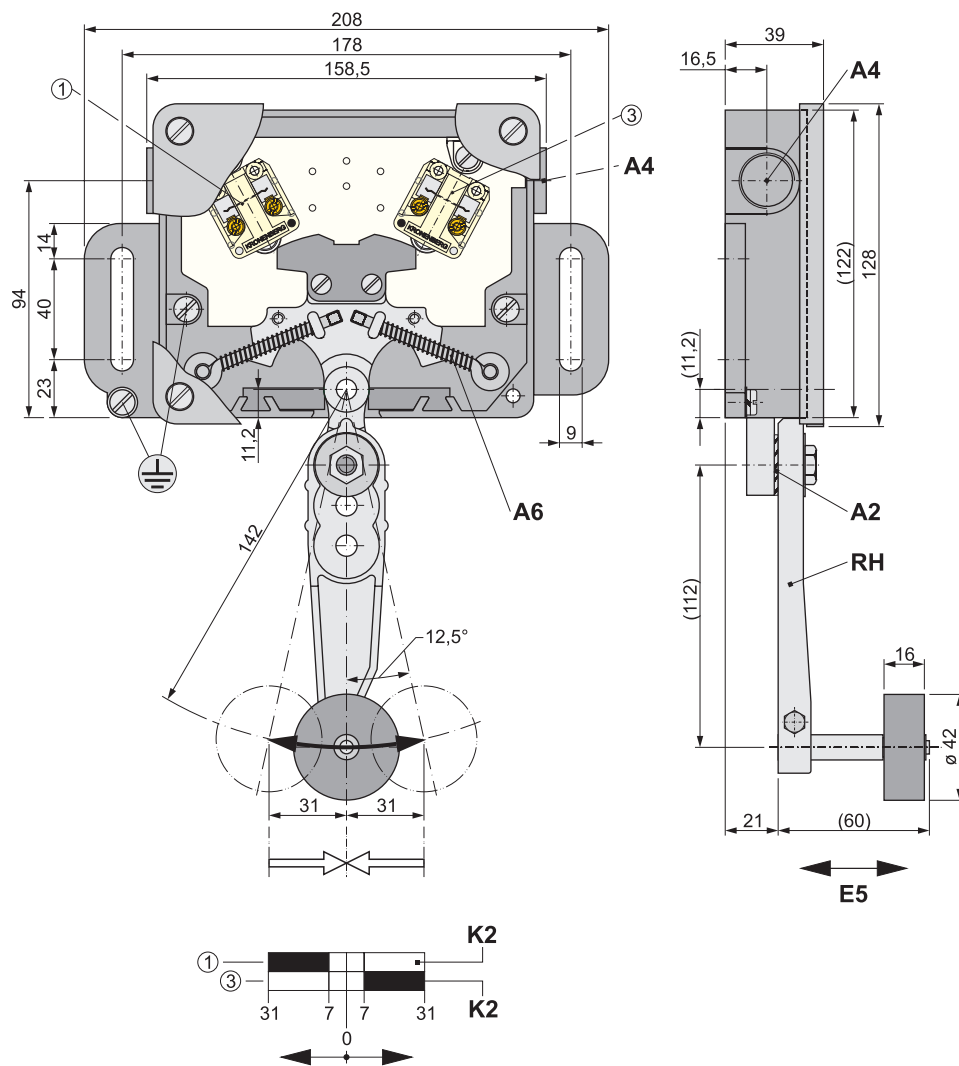

 Kontakt geschlossen (zwangsöffnend)  
contact closed (positively opening)

 Kontakt offen  
contact open

 Betätigungsrichtung / actuating direction

 Federrückzug / spring return

A2 Zahnscheibe, zwischen den Hebeln angeordnet  
tooth pad, arranged between the levers

A4 Kabeleinführung / cable entry

A6 Feder / spring

E5 Position der Gummirolle (G60) einstellbar  
position of the rubber roller (G60) adjustable





K2 Schließerkontakt  
normally open contact

RH Rollenhebel, Position einstellbar  
roller lever, position adjustable

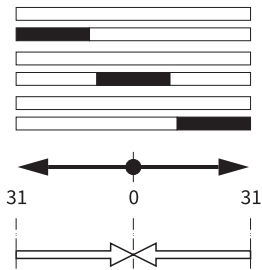
Schaltweg-Diagramm (Sonderschaltungen)  
contact sequence diagram (special circuits):

FS-3-07



-  Federrückzug / spring return
-  Betätigungsrichtung in mm  
actuating direction in mm
-  Kontakt geschlossen (zwangsoffnend)  
contact closed (positively opening)
-  Kontakt offen  
contact open