

Max-Air

TECHNOLOGY

The Best Way To Automate Your Process

**Italian Made
Pneumatic &
Hydraulic
Scotch Yoke
Actuators**

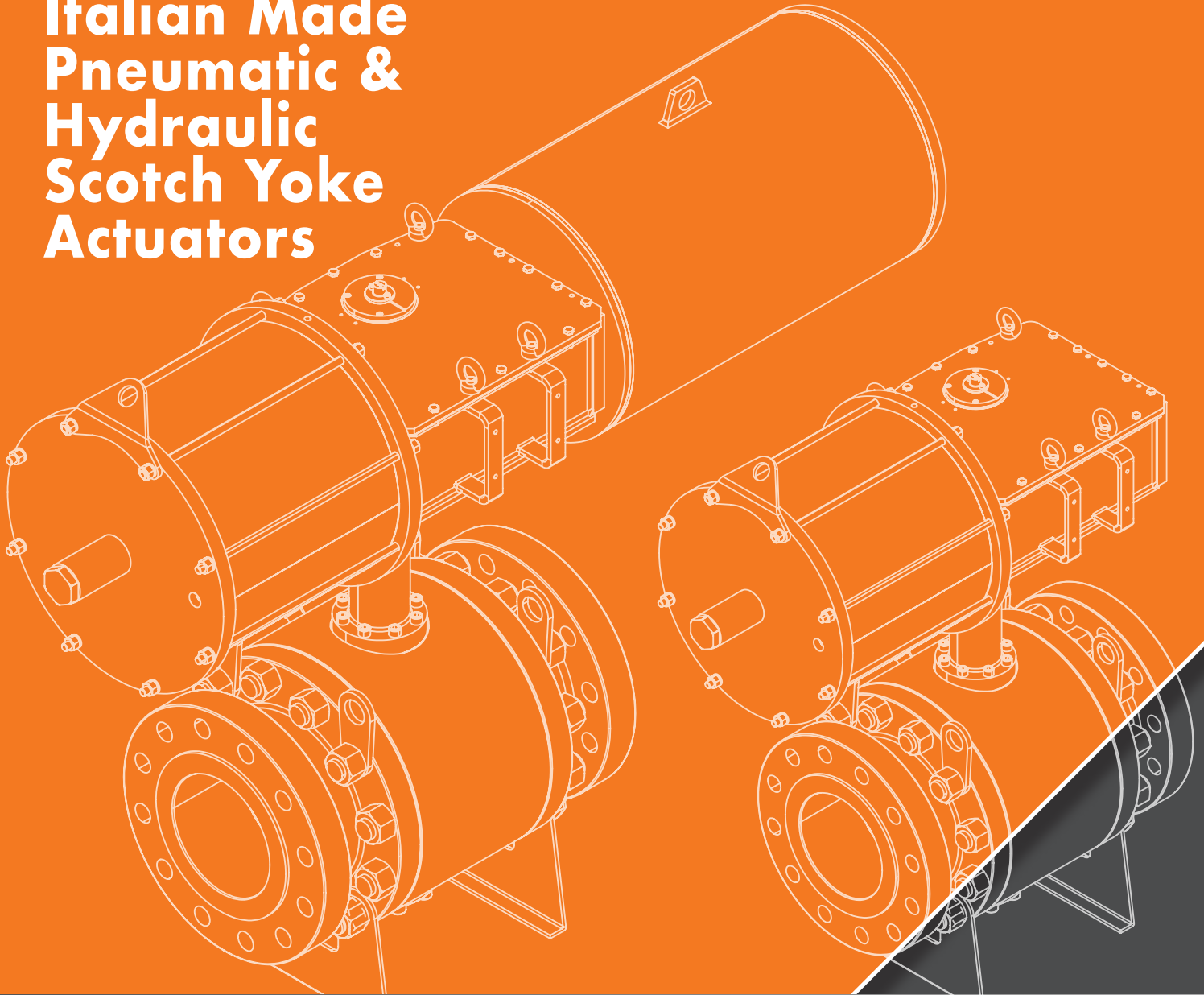

AG Series Technical Brochure

Max-Air Technology Inc. | Rotary Actuators & Valve Automation Solutions

AG Series Scotch Yoke Actuators

Italian made scotch yoke actuators designed for peak performance & reliability.

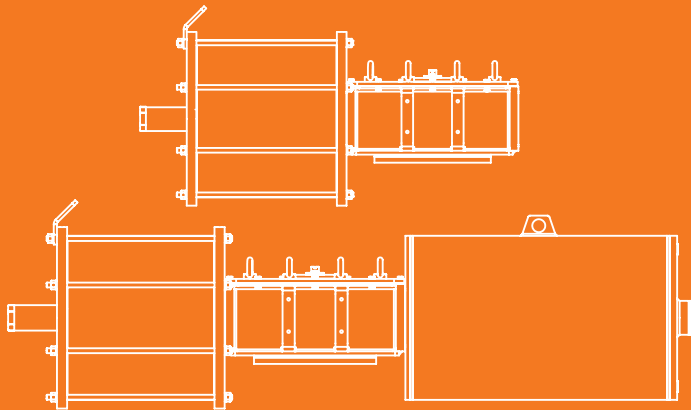

Max Air Technology is proud to introduce the new AG Series scotch yoke actuator. Designed and manufactured 100% in Italy, this actuator is built to last with a 25-year design life. Years of manufacturing and design experience have culminated into our unique Guided-Motion concept, which provides superior performance, longevity, and flexibility. Additional details such as high-grade materials, precision machined components, and rigorous quality control all contribute to a robust construction that outperforms the competition.

AG Series Part Number Builder

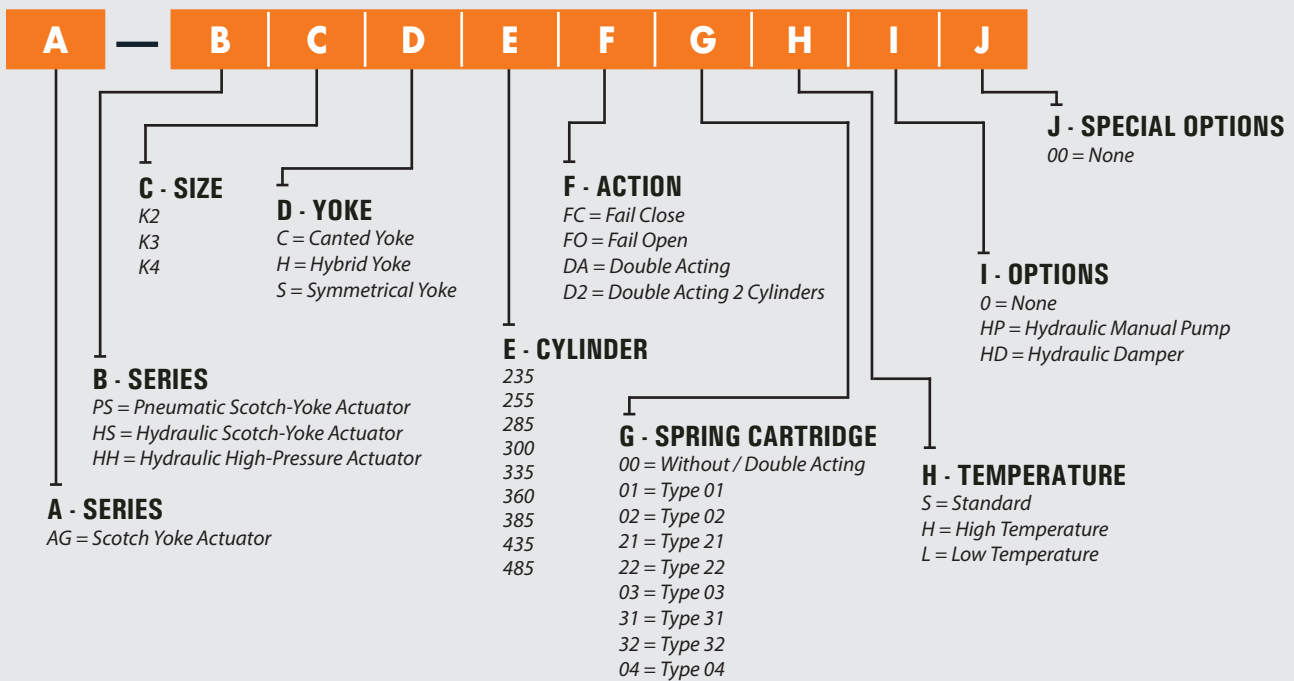

Seal Options

SEALS	CODE	TEMP RANGE
Standard (BUNA-N)	S	-4°F (-20°C) to 176°F (80°C)
High Temp. (VITON)	H	-10°F (-23°C) to 250°F continuous and 300°F cyclic
Low Temp. (Silicone)	L	-40°F (-40°C) to 176°F (80°C)





Table of Contents

Pg - Description

[02 - Part Number Builder](#)

[03 - Table of Contents](#)

[04 - Features & Benefits](#)

[08 - Exploded Views & Materials](#)

[10 - Symmetric Yokes: Double Acting Torques & Sizing](#)

[14 - Symmetric Yokes: Spring Return Torques & Sizing](#)

[38 - Canted Yokes: Double Acting Torques & Sizing](#)

[40 - Canted Yokes: Spring Return Torques & Sizing](#)



STANDARD WARRANTY

Max-Air Technology Inc. | The Best Way to Automate Your Process

Max-Air Technology provides the following warranty regarding products manufactured by it. **THE WARRANTY STATED HEREIN IS EXPRESSLY IN LIEU OF ALL OTHER WARRANTIES AND REPRESENTATIONS, EXPRESSED OR IMPLIED, OR STATUTORY, INCLUDING, WITHOUT LIMITATION, THE IMPLIED WARRANTY OF FITNESS FOR A PARTICULAR PURPOSE.** Max-Air Technology warrants its products to be free from defects in materials and workmanship when these products are used for the purpose for which they were designed and manufactured. Max-Air Technology does not warrant its products against chemical or stress corrosion or against any other failure other than from defects in materials or workmanship. The warranty period is for twelve (12) months from installation date or eighteen (18) months from shipment date, whichever date comes first. Any claims regarding this warranty must be in writing and received by Max-Air Technology before the last effective date of the warranty period. Upon Max-Air Technology's receipt of a warranty claim, Max-Air Technology reserves the right to inspect the product(s) in question at either the field location or at the Max-Air Technology Manufacturing plant. If, after inspection of the product(s) in question, Max-Air Technology determines that the purchaser's claim is covered by this warranty, Max-Air Technology's sole liability and the purchaser's sole remedy under this warranty is limited to the refunding of the purchase price or repair or replacement thereof at Max-Air Technology option. Max-Air Technology will not be liable for any repairs, labor, material or other expenses that are not specifically authorized in writing by Max-Air Technology, and in no event shall Max-Air Technology be liable for any direct or consequential damages arising out of any defect from any cause whatsoever. If any Max-Air Technology product is modified or altered at any location other than Max-Air Technology – St. Louis (Missouri) UNITED STATES or Max-Air Technology – Agrate Brianza (MB) ITALY without the express written authorization of Max-Air Technology, said product is not covered by this warranty. The warranty for such products shall be subject only to the warranty relief, if any, provided by the suppliers and/or manufacturers of such products.

Features & Benefits

Italian made scotch yoke actuators designed for peak performance & reliability.

Pneumatic Actuators for Peak Heavy Duty Performance

Max Air Technology is proud to introduce the new AG Series scotch yoke actuator. Designed and manufactured 100% in Italy, this actuator is built to last with a 25-year design life. Years of manufacturing and design experience have culminated into our unique Guided-Motion concept, which provides superior performance, longevity, and flexibility. Additional details such as high-grade materials, precision machined components, and rigorous quality control all contribute to a robust construction that outperforms the competition.

Features:

- Dual linear travel stops are uniquely designed for repeatable, high speed operation. Standard travel stops provide +/- 5 degrees adjustment; more is available with extended travel stops.
- Pneumatic cylinder has a max rated pressure of up to 175 psi (12 bar)
- Electroless nickel plated cylinders, chrome plated guide rods.
- High and low temperature seal options available.
- High visibility progressive position indicator on center module cover.
- Namur switch interface on top plate.
- Accessory mounting panels on both sides.
- ISO 5211 standard valve interface dimensions.

Options:

- Hand Pump Override
- Pre-Engineered Panel Selections

Designed & Built to Last:

Strong design including increased safety factors for critical components, high quality materials and coatings, precise machining and enhanced quality control allow the AG series to withstand the most challenging applications.



Specifications:

Rotation	90° +/- 5°
Housing	Carbon Steel
Yoke	High Carbon Steel - Phosphate Coating
Guide Rods	Chrome Plated Carbon Steel
Power Cylinder	Carbon Steel, Internal Electroless Nickel Plated
Spring	51CrV4 Steel - Epoxy Painting
Ambient Temp. Range	-4°F to 176°F Standard (-40°F Low, 300°F High)
Max Operating Pressure	175 psi (12 bar)
Torque Range	13,000 in-lbs to 300,000 in-lbs (DA)
Valve Mounting	ISO 5211
Top Accessory Mounting	NAMUR VDI/VDE 3845

Sizes to Cover
Torques from
13,000 in-lbs to
300,000 in-lbs!



Seal Options

SEALS	CODE	TEMP RANGE
Standard (BUNA-N)	S	-4°F (-20°C) to 176°F (80°C)
High Temp. (VITON)	H	-10°F (-23°C) to 250°F continuous and 300°F cyclic
Low Temp. (Silicone)	L	-40°F (-40°C) to 176°F (80°C)

AG Series Technical Brochure

Max-Air Technology Inc. | Rotary Actuators & Valve Automation Solutions



maxairtech.com

Guided-Motion Design

Our unique Guided-Motion design uses strategically placed bearings and alignment features to ensure a calibrated arrangement of rotational and linear movements. Better alignment virtually eliminates side-loading strain, minimizes efficiency loss, and reduces wear on sliding surfaces. Additionally, these guiding elements are sealed and protected against ingress of water or particulates.

Dual Linear Bushings

Dual linear bushings in the power module.

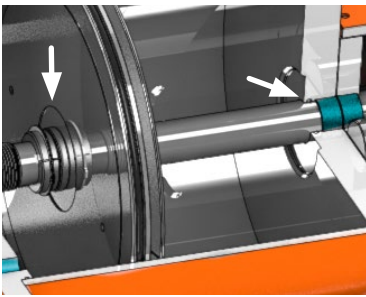

Dual Rotary Bearings

Dual rotary bearings on the top and bottom of the yoke.

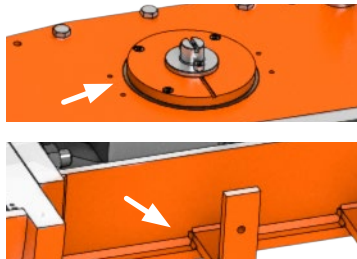

Adjustable Travel Stops

AG Series actuators are all provided with bi-directional travel stops to allow for open and closed position location adjustments of $\pm 5^\circ$ standard.

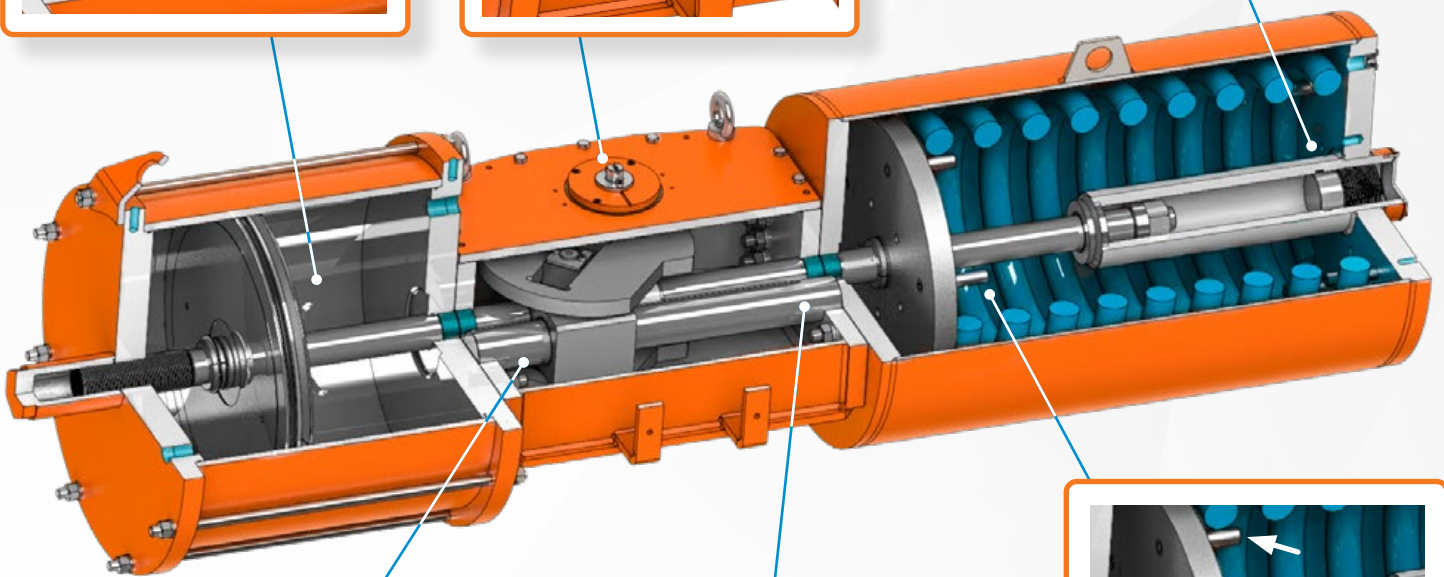
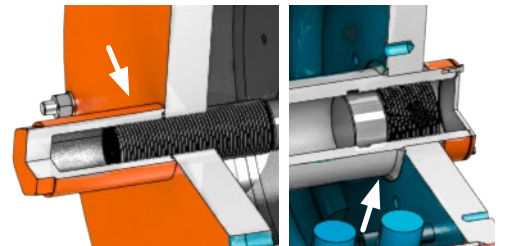
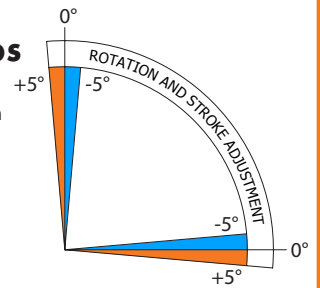

Dual Sliding Bearings

Dual sliding bearings within the yoke mechanism for smooth controlled movement during the conversion of linear movement to rotation, and dual linear guide bushings.

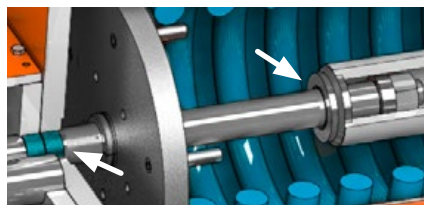

Dual Linear Bushings w/ Guide Rod

Dual linear bushings with guide rod in the spring module.

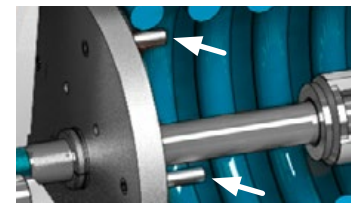

Alignment Pins

Alignment pins within the spring chamber to assure centering of the spring's coils.

Flexibility & Superior Safety

Modular Design, Operating Media, Easy Assembly, Serviceable, Tie Rod Power Module, & Welded Spring Cartridge

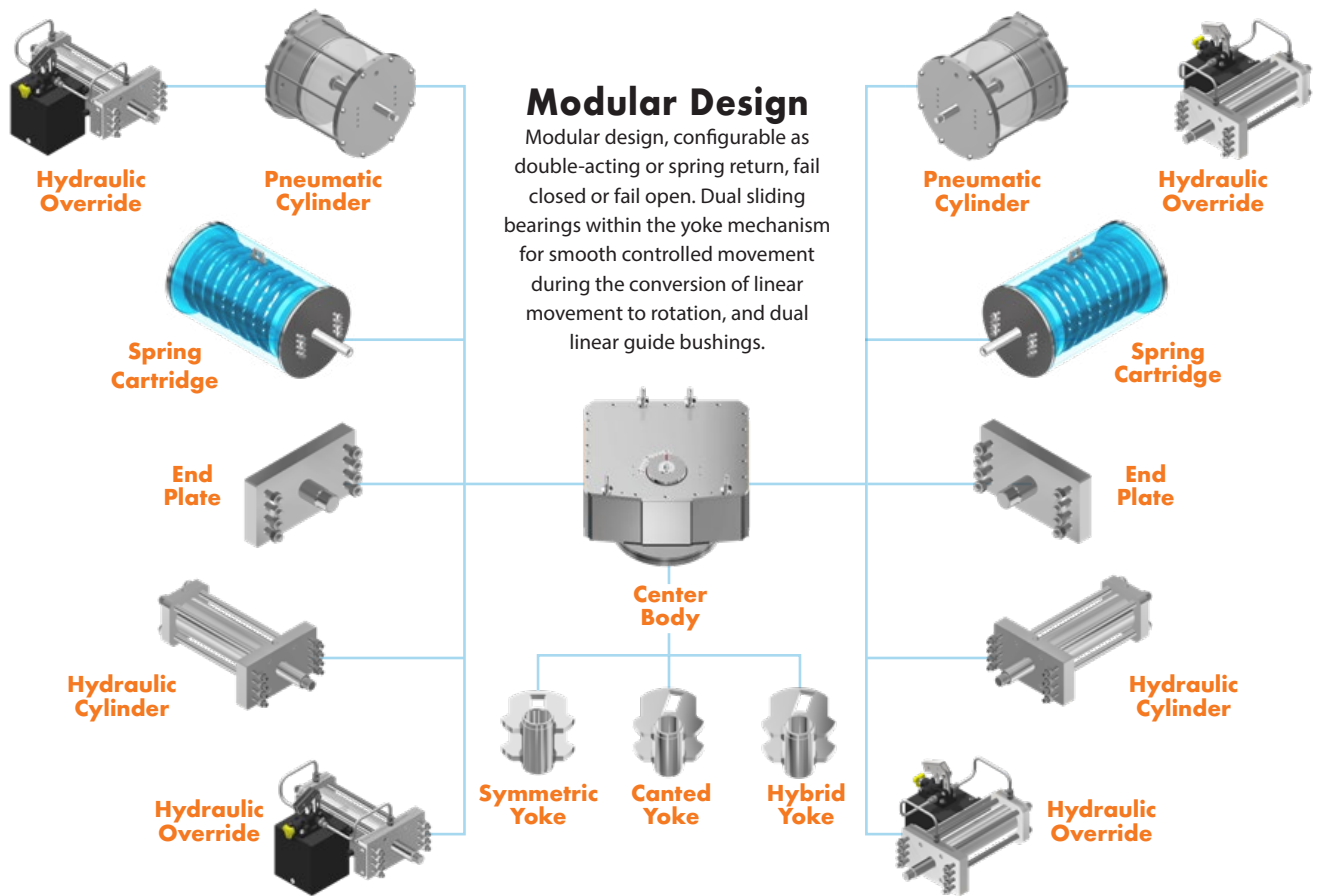

Safe & Serviceable

Designed to be Serviceable & Safe in Any Configuration.

Tie Rod Power Module

Tie rod power module design with a high safety factor for accidental over-pressurization.

Easy Assembly & Serviceable

Actuator construction is designed for easy assembly, making field refurbishment and modifications relatively simple.

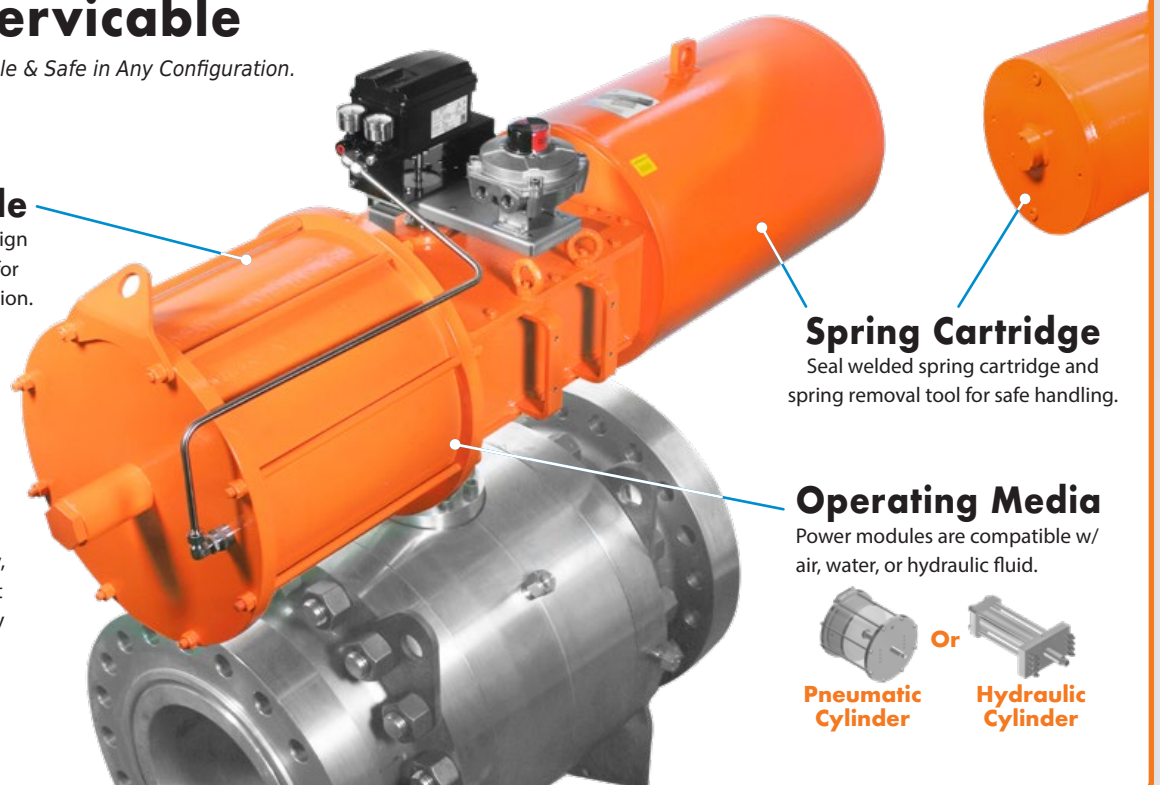

AG Series Technical Brochure

Max-Air Technology Inc. | Rotary Actuators & Valve Automation Solutions



maxairtech.com

Yoke Mechanism

AG Series is available with symmetric, canted or hybrid yoke mechanism allowing to select the best torque curve characteristic for each specific valve and therefore minimizing actuator size, weight and cost.

DOUBLE ACTING - SYMMETRIC YOKE

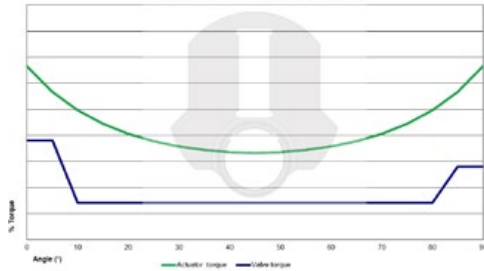

SYMMETRIC TORQUE CURVE

In this configuration AG unit produces maximum torques at both ends of the stroke (0° and 90°) and minimal in the middle, therefore this series is the optimal solution for metal seated ball valves, plug valves and for modulating service.

DOUBLE ACTING - CANTED YOKE

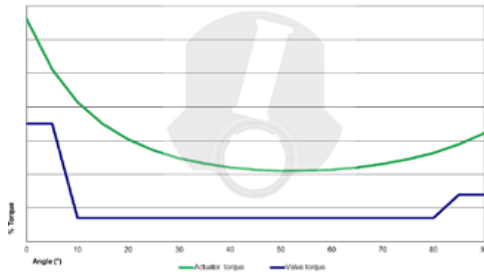

HYBRID TORQUE CURVE

In this configuration AG unit is equipped with a customized yoke which produces an hybrid torque curve between canted and symmetric ones.

CUSTOM YOKE

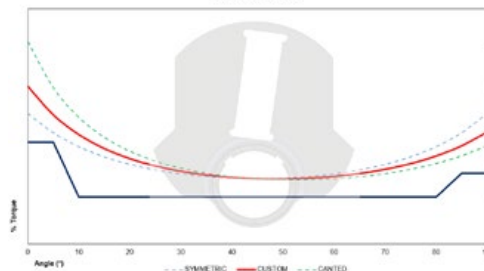

CANTED TORQUE CURVE

In this configuration AG unit produces a higher maximum torque at the beginning of the stroke (i.e. valve unseating/reseating at 0°) and less torque at the end of the stroke (90°), therefore this series is optimal solution for high performance butterfly valves.

Design Verification

Max-Air has conducted extensive analysis of the actuator's components to assure service life.

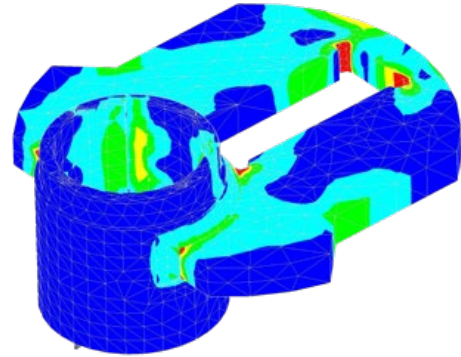

Quality

Produced in an ISO 9001 facility, quality standards are strictly verified to assure compliance with design specifications.



Technical Data

Exploded View & Materials of Construction

AG Series

Cutaway View & Bill of Materials

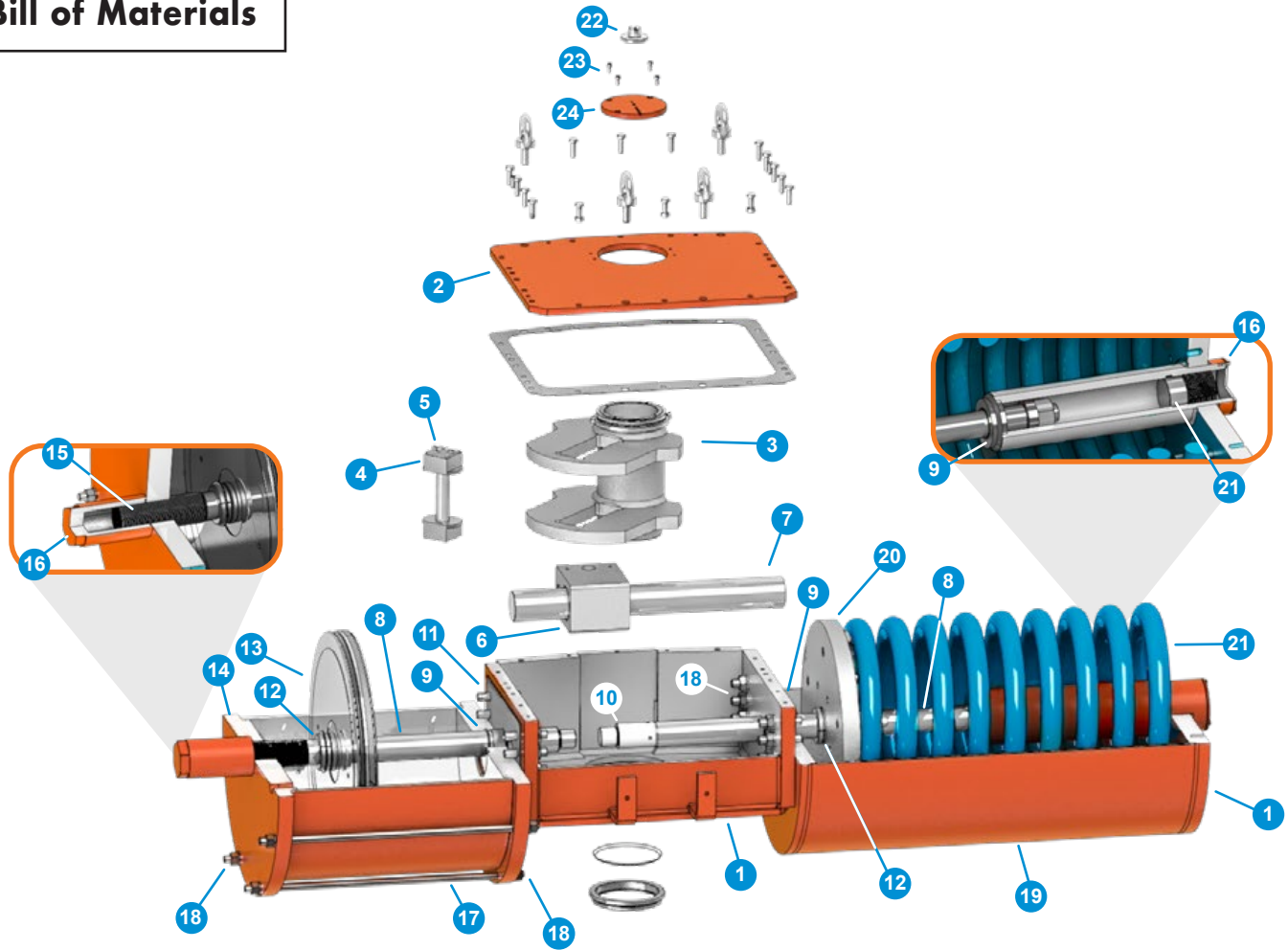

No.	DESCRIPTION	MATERIAL
1	Housing	Carbon Steel
2	Cover	Carbon Steel
3	Yoke	High Carbon Steel - Phosphate Coating
4	Slider Block	Hard Bronze Alloy
5	Yoke Pin	41CRMO3 - Chrome Bar
6	Guide Block	39NiCrMo3 Steel
7	Housing Guide Rod	42CrMo4 Steel
8	Spring Guide Rod	42CrMo4 Steel
9	Centering Bushing	Steel - Composite Polymer
10	Yoke Bushing	Hard Bronze Alloy
11	Cover Gasket	Fiber
12	Retainer Ring	39NiCrMo3 Steel

No.	DESCRIPTION	MATERIAL
13	Piston	Carbon Steel - Electrol Nickle Plating
14	End Cap	Carbon Steel - Electrol Nickle Plating
15	Mechanical Stop	39NiCrMo3 Steel
16	Mechanical Stop Plug	Carbon Steel
17	Tie Rod	ASTM A193 B7
18	Nut	ASTM 194 2H
19	Springe Cartridge	Carbon Steel
20	Spring Plate	Carbon Steel
21	Spring	51CrV4 Steel - Epoxy Painting
22	NAMUR Accessory Drive	Stainless Steel
23	NAMUR Indicator Screws	Stainless Steel
24	NAMUR Indicator	Stainless Steel

AG Series Technical Brochure

Max-Air Technology Inc. | Rotary Actuators & Valve Automation Solutions



maxairtech.com

This page intentionally left blank.

Double Acting Symmetric Torque Data

K2, K3, & K4 Sizes, Double Acting, Symmetric Yoke

K2 Size - Double Acting

Symmetric Yoke



Torques

Model	Pos.	40 PSI	50 PSI	60 PSI	70 PSI	80 PSI	90 PSI	100 PSI	110 PSI	120 PSI	140 PSI	160 PSI	170 PSI
AG-PSK2S235DA	start	13859	17323	20788	24253	27717	31182	34647	38111	41576	48506	55435	58900
	run	7559	9449	11339	13229	15119	17008	18898	20788	22678	26458	30237	32127
	end	14399	17998	21598	25198	28797	32397	35997	39596	43196	50395	57595	61194
AG-PSK2S255DA	start	16318	20398	24477	28557	32636	36716	40795	44875	48954	57113	65272	69352
	run	8901	11126	13351	15576	17801	20027	22252	24477	26702	31153	35603	37828
	end	16954	21192	25431	29669	33908	38146	42385	46623	50861	59338	67815	72054
AG-PSK2S285DA	start	20383	25479	30575	35671	40767	45863	50959	56054	61150	71342	81534	86630
	run	11118	13898	16677	19457	22236	25016	27796	30575	33355	38914	44473	47253
	end	21178	26472	31766	37061	42355	47650	52944	58238	63533	74122	84710	90005
AG-PSK2S300DA	start	22586	28232	33878	39525	45171	50817	56464	62110	67757	79049	90342	-
	run	12319	15399	18479	21559	24639	27719	30798	33878	36958	43118	49277	-
	end	23465	29332	35198	41065	46931	52797	58664	64530	70396	82129	90636	-
AG-PSK2S335DA	start	28163	35204	42244	49285	56326	63366	70407	77448	84489	-	-	-
	run	15362	19202	23042	26883	30723	34564	38404	42244	46085	-	-	-
	end	29260	36575	43890	51205	58520	65835	73150	80465	87780	-	-	-
AG-PSK2S360DA	start	32523	40654	48785	56916	65046	73177	81308	-	-	-	-	-
	run	17740	22175	26610	31045	35480	39915	44350	-	-	-	-	-
	end	33790	42238	50685	59133	67581	76028	84476	-	-	-	-	-
AG-PSK2S385DA	start	37197	46496	55796	65095	74394	83693	-	-	-	-	-	-
	run	20289	25362	30434	35506	40579	45651	-	-	-	-	-	-
	end	38646	48308	57970	67631	77293	86954	-	-	-	-	-	-
AG-PSK2S435DA	start	47486	59358	71229	83101	94972	-	-	-	-	-	-	-
	run	25901	32377	38852	45328	51803	-	-	-	-	-	-	-
	end	49336	61670	74004	86338	98672	-	-	-	-	-	-	-
AG-PSK2S485DA	start	59030	73787	88545	-	-	-	-	-	-	-	-	-
	run	32198	40248	48297	-	-	-	-	-	-	-	-	-
	end	61330	76662	91994	-	-	-	-	-	-	-	-	-

AG Series Technical Brochure

Max-Air Technology Inc. | Rotary Actuators & Valve Automation Solutions



maxairtech.com

K3 Size - Double Acting Symmetric Yoke



Torques

Model	Pos.	40 PSI	50 PSI	60 PSI	70 PSI	80 PSI	90 PSI	100 PSI	110 PSI	120 PSI	140 PSI	160 PSI	170 PSI
AG-PSK3S285DA	start	25834	32292	38750	45209	51667	58125	64584	71042	77501	90417	103334	109793
	run	13734	17168	20601	24035	27469	30902	34336	37769	41203	48070	54937	58371
	end	26161	32701	39241	45781	52321	58861	65401	71942	78482	91562	104642	111182
AG-PSK3S300DA	start	28624	35781	42937	50093	57249	64405	71561	78717	85873	100186	114498	121654
	run	15218	19023	22827	26632	30436	34241	38045	41850	45654	53263	60872	64677
	end	28987	36233	43480	50727	57974	65220	72467	79714	86960	101454	115947	123194
AG-PSK3S335DA	start	35693	44616	53540	62463	71386	80309	89233	98156	107079	124926	142772	151696
	run	18976	23720	28464	33208	37952	42696	47440	52184	56928	66416	75904	80648
	end	36145	45181	54217	63254	72290	81326	90362	99398	108435	126507	144580	153616
AG-PSK3S360DA	start	41219	51524	61829	72134	82438	92743	103048	113353	123658	144267	164877	-
	run	21914	27392	32871	38349	43828	49306	54785	60263	65742	76699	87656	-
	end	41741	52176	62611	73047	83482	93917	104352	114788	125223	146093	166964	-
AG-PSK3S385DA	start	47143	58929	70714	82500	94286	106071	117857	129643	141429	-	-	-
	run	25063	31329	37595	43861	50127	56392	62658	68924	75190	-	-	-
	end	47740	59674	71609	83544	95479	107414	119349	131284	143219	-	-	-
AG-PSK3S435DA	start	60183	75229	90274	105320	120366	135411	150457	-	-	-	-	-
	run	31996	39995	47994	55993	63992	71991	79990	-	-	-	-	-
	end	60945	76181	91417	106653	121889	137126	152362	-	-	-	-	-
AG-PSK3S485DA	start	74813	93516	112220	130923	149626	168330	-	-	-	-	-	-
	run	39774	49718	59661	69605	79548	89492	-	-	-	-	-	-
	end	75760	94700	113640	132580	151520	170460	-	-	-	-	-	-
AG-PSK3S535DA	start	91034	113792	136550	159309	-	-	-	-	-	-	-	-
	run	48398	60497	72596	84696	-	-	-	-	-	-	-	-
	end	92186	115232	138279	161325	-	-	-	-	-	-	-	-
AG-PSK3S585DA	start	108844	136055	163267	-	-	-	-	-	-	-	-	-
	run	57867	72333	86800	-	-	-	-	-	-	-	-	-
	end	110222	137778	165333	-	-	-	-	-	-	-	-	-

Double Acting Symmetric Torque Data

K2, K3, & K4 Sizes, Double Acting, Symmetric Yoke

K2 Size - Double Acting

Symmetric Yoke



Torques

Model	Pos.	40 PSI	50 PSI	60 PSI	70 PSI	80 PSI	90 PSI	100 PSI	110 PSI	120 PSI	140 PSI	160 PSI	170 PSI
AG-PSK4S335DA	start	45891	57364	68837	80309	91782	103255	114728	126201	137673	160619	183564	195037
	run	24398	30497	36597	42696	48796	54895	60994	67094	73193	85392	97591	103691
	end	46472	58090	69708	81326	92944	104562	116180	127798	139416	162652	185888	197506
AG-PSK4S360DA	start	52996	66245	79494	92743	105992	119241	132490	145739	158988	185486	211984	225233
	run	28175	35219	42263	49306	56350	63394	70438	77482	84525	98613	112701	119744
	end	53667	67084	80500	93917	107334	120751	134167	147584	161001	187834	214668	228084
AG-PSK4S385DA	start	60612	75765	90918	106071	121224	136378	151531	166684	181837	212143	242449	257602
	run	32224	40280	48336	56392	64448	72505	80561	88617	96673	112785	128897	136953
	end	61379	76724	92069	107414	122759	138104	153449	168794	184138	214828	245518	260863
AG-PSK4S435DA	start	77378	96722	116067	135411	154756	174100	193445	212789	232134	270823	298875	86086
	run	41138	51422	61706	71991	82275	92560	102844	113129	123413	143982	158896	45767
	end	78357	97947	117536	137126	156715	176304	195894	215483	235072	274251	302659	87176
AG-PSK4S485DA	start	96188	120235	144282	168330	192377	216424	240471	264518	288565	-	-	-
	run	51138	63923	76707	89492	102276	115061	127845	140630	153414	-	-	-
	end	97406	121757	146109	170460	194812	219163	243515	267866	292218	-	-	-
AG-PSK4S535DA	start	117043	146304	175565	204826	234086	263347	292608	-	-	-	-	-
	run	62226	77782	93338	108895	124451	140007	155564	-	-	-	-	-
	end	118525	148156	177787	207418	237050	266681	296312	-	-	-	-	-
AG-PSK4S585DA	start	139943	174928	209914	244900	279886	314871	-	-	-	-	-	-
	run	74400	93000	111600	130200	148800	167400	-	-	-	-	-	-
	end	141714	177143	212571	248000	283428	318857	-	-	-	-	-	-
AG-PSK4S635DA	start	164887	206109	247330	288552	-	-	-	-	-	-	-	-
	run	87661	109577	131492	153407	-	-	-	-	-	-	-	-
	end	166974	208718	250461	292205	-	-	-	-	-	-	-	-
AG-PSK4S685DA	start	191876	239845	287814	-	-	-	-	-	-	-	-	-
	run	102010	127512	153015	-	-	-	-	-	-	-	-	-
	end	194304	242881	291457	-	-	-	-	-	-	-	-	-

AG Series Technical Brochure

Max-Air Technology Inc. | Rotary Actuators & Valve Automation Solutions



maxairtech.com

Spring Return Symmetric Torque Data

K2, K3, & K4 Sizes w/ Various Spring Cartridges, Symmetric Yoke

K2 Size - Spring 01

Symmetric Yoke



Torques

Model	Pos.	Spring Torque in-lbs	40 PSI	50 PSI	60 PSI	70 PSI	80 PSI	90 PSI	100 PSI	110 PSI	120 PSI	140 PSI	160 PSI	170 PSI
AG-PSK2S235FC01	start	15268	-	-	12151	15751	19351	22950	26550	30150	33749	40949	48148	51748
	run	6488	-	-	4851	6741	8631	10521	12411	14301	16190	19970	23750	25640
	end	9447	-	-	6330	9930	13530	16911	19777	23886	27928	35128	42327	45927
AG-PSK2S255FC01	start	15268	-	11746	15984	20223	24461	28699	32938	37176	41415	49892	58369	62607
	run	6488	-	4638	6864	9089	11314	13539	15764	17990	20215	24665	29115	31341
	end	9447	-	5925	10163	14401	18640	22878	27117	31355	35594	44071	52547	56786
AG-PSK2S285FC01	start	15268	11731	17025	22320	27614	32909	38203	43497	48792	54086	64675	75264	80558
	run	6488	4631	7410	10190	12969	15749	18529	21308	24088	26867	32426	37985	40765
	end	8974	5910	11204	16499	21793	27087	32382	37676	42971	48265	58854	69443	74737
AG-PSK2S300FC01	start	15268	14019	19885	25752	31618	37484	43351	49217	55083	60950	72683	84415	-
	run	6488	5832	8912	11992	15071	18151	21231	24311	27391	30471	36630	42790	-
	end	9447	8198	14064	19930	25797	31663	37530	43396	49262	55129	66861	78594	-
AG-PSK2S335FC01	start	15268	19813	27129	34444	41759	49074	56389	63704	71019	78334	-	-	-
	run	6488	8874	12714	16555	20395	24236	28076	31916	35757	39597	-	-	-
	end	9447	13992	21307	28622	35938	43253	50568	57883	65198	72513	-	-	-
AG-PSK2S360FC01	start	15268	24344	32791	41239	49686	58134	66581	75029	83477	91924	-	-	-
	run	6488	11252	15687	20122	24557	28992	33427	37862	42297	46732	-	-	-
	end	9447	18523	26970	35418	43865	52313	60760	69208	77656	86103	-	-	-
AG-PSK2S385FC01	start	15268	29200	38861	48523	58184	67846	77508	87169	-	-	-	-	-
	run	6488	13802	18874	23946	29019	34091	39163	44236	-	-	-	-	-
	end	9447	23379	33040	42702	52363	62025	71687	81348	-	-	-	-	-
AG-PSK2S435FC01	start	15268	39890	52224	64558	76892	-	-	-	-	-	-	-	-
	run	6488	19414	25889	32365	38840	-	-	-	-	-	-	-	-
	end	9447	34068	46402	58736	71071	-	-	-	-	-	-	-	-
AG-PSK2S485FC01	start	15268	51883	67215	82548	-	-	-	-	-	-	-	-	-
	run	6488	25711	33760	41810	-	-	-	-	-	-	-	-	-
	end	9447	46062	61394	76727	-	-	-	-	-	-	-	-	-

AG Series Technical Brochure

Max-Air Technology Inc. | Rotary Actuators & Valve Automation Solutions



maxairtech.com

K2 Size - Spring 11

Symmetric Yoke



Torques

Model	Pos.	Spring Torque in-lbs	40 PSI	50 PSI	60 PSI	70 PSI	80 PSI	90 PSI	100 PSI	110 PSI	120 PSI	140 PSI	160 PSI	170 PSI
AG-PSK2S235FC11	start	23912	-	-	-	-	8276	17117	20717	24317	27916	35116	42315	45915
	run	10288	-	-	-	-	3176	6721	8611	10500	12390	16170	19950	21839
	end	15280	-	-	-	-	3824	8356	11520	15422	19285	26484	33683	37283
AG-PSK2S255FC11	start	23912	-	-	-	12772	18628	22866	27105	31343	35582	44059	52535	56774
	run	10288	-	-	-	4833	7514	9739	11964	14189	16415	20865	25315	27540
	end	15280	-	-	-	5640	9996	14235	18473	22711	26950	35427	43904	48142
AG-PSK2S285FC11	start	23912	-	-	16487	21781	27075	32370	37664	42959	48253	58842	69431	74725
	run	10288	-	-	6390	9169	11949	14728	17508	20287	23067	28626	34185	36965
	end	15280	-	-	7855	13149	18444	23738	29032	34327	39621	50210	60799	66093
AG-PSK2S300FC11	start	23912	-	14052	19918	25785	31651	37518	43384	49250	55117	66849	78582	84448
	run	10288	-	5111	8191	11271	14351	17431	20511	23591	26670	32830	38990	42070
	end	15280	-	5420	11287	17153	23019	28886	34752	40619	46485	58218	69950	75817
AG-PSK2S335FC11	start	23912	13980	21295	28610	35925	43241	50556	57871	65186	72501	-	-	-
	run	10288	5074	8914	12755	16595	20435	24276	28116	31957	35797	-	-	-
	end	15280	5349	12664	19979	27294	34609	41924	49239	56554	63869	-	-	-
AG-PSK2S360FC11	start	23912	18510	26958	35406	43853	52301	60748	69196	77643	86091	-	-	-
	run	10288	7452	11887	16322	20757	25192	29627	34062	38497	42932	-	-	-
	end	15280	9879	18326	26774	35221	43669	52117	60564	69012	77459	-	-	-
AG-PSK2S385FC11	start	23912	23367	33028	42690	52351	62013	71674	81336	-	-	-	-	-
	run	10288	10002	15074	20146	25219	30291	35363	40436	-	-	-	-	-
	end	15280	14735	24396	34058	43720	53381	63043	72704	-	-	-	-	-
AG-PSK2S435FC11	start	23912	34056	46390	58724	71058	-	-	-	-	-	-	-	-
	run	10288	15614	22089	28565	35040	-	-	-	-	-	-	-	-
	end	15280	25425	37759	50093	62427	-	-	-	-	-	-	-	-
AG-PSK2S485FC11	start	23912	46050	61382	63590	12795	-	-	-	-	-	-	-	-
	run	10288	21910	29960	31429	6324	-	-	-	-	-	-	-	-
	end	15280	37418	52751	56139	11296	-	-	-	-	-	-	-	-

Spring Return Symmetric Torque Data

K2, K3, & K4 Sizes w/ Various Spring Cartridges, Symmetric Yoke

K2 Size - Spring 02

Symmetric Yoke



Torques

Model	Pos.	Spring Torque in-lbs	40 PSI	50 PSI	60 PSI	70 PSI	80 PSI	90 PSI	100 PSI	110 PSI	120 PSI	140 PSI	160 PSI	170 PSI
AG-PSK2S235FC02	start	31080	-	-	-	-	-	-	14950	19759	23359	30558	37758	41357
	run	13366	-	-	-	-	-	-	5208	7422	9312	13092	16872	18761
	end	19837	-	-	-	-	-	-	4647	8403	12116	19316	26515	30115
AG-PSK2S255FC02	start	31080	-	-	-	-	-	18309	22548	26786	31024	39501	47978	52217
	run	13366	-	-	-	-	-	6661	8886	11111	13337	17787	22237	24463
	end	19837	-	-	-	-	-	7066	11305	15543	19782	28259	36736	40974
AG-PSK2S285FC02	start	31080	-	-	2540	15334	22518	27813	33107	38401	43696	54285	64873	70168
	run	13366	-	-	929	5612	8871	11650	14430	17210	19989	25548	31107	33887
	end	19837	-	-	1001	6044	11276	16570	21864	27159	32453	43042	53631	58925
AG-PSK2S300FC02	start	31080	-	-	3107	18762	27094	32960	38827	44693	50559	62292	74025	79891
	run	13366	-	-	1227	7411	11273	14353	17433	20513	23593	29752	35912	38992
	end	19837	-	-	1569	9472	15851	21718	27584	33450	39317	51050	62782	68649
AG-PSK2S335FC02	start	31080	-	-	24053	31368	38683	45998	53313	60628	67943	82574	-	-
	run	13366	-	-	9677	13517	17358	21198	25038	28879	32719	40400	-	-
	end	19837	-	-	12811	20126	27441	34756	42071	49386	56701	71331	-	-
AG-PSK2S360FC02	start	31080	-	20620	30848	39296	47744	56191	64639	73086	81534	-	-	-
	run	13366	-	8185	13244	17679	22114	26549	30984	35419	39854	-	-	-
	end	19837	-	10561	19606	28053	36501	44949	53396	61844	70291	-	-	-
AG-PSK2S385FC02	start	31080	18809	28471	38133	47794	57456	67117	76779	86440	96102	-	-	-
	run	13366	6924	11996	17068	22141	27213	32285	37358	42430	47502	-	-	-
	end	19837	7567	17228	26890	36552	46213	55875	65536	75198	84859	-	-	-
AG-PSK2S435FC02	start	31080	29499	41833	54167	66501	78835	91169	-	-	-	-	-	-
	run	13366	12536	19011	25487	31962	38437	44913	-	-	-	-	-	-
	end	19837	18257	30591	42925	55259	67593	79927	-	-	-	-	-	-
AG-PSK2S485FC02	start	31080	41493	56825	72157	87490	-	-	-	-	-	-	-	-
	run	13366	18832	26882	34931	42981	-	-	-	-	-	-	-	-
	end	19837	30250	45582	60915	76247	-	-	-	-	-	-	-	-

AG Series Technical Brochure

Max-Air Technology Inc. | Rotary Actuators & Valve Automation Solutions



maxairtech.com

K2 Size - Spring 21

Symmetric Yoke



Torques

Model	Pos.	Spring Torque in-lbs	40 PSI	50 PSI	60 PSI	70 PSI	80 PSI	90 PSI	100 PSI	110 PSI	120 PSI	140 PSI	160 PSI	170 PSI
AG-PSK2S235FC21	start	40242	-	-	-	-	-	-	-	-	5967	25209	32408	36008
	run	17175	-	-	-	-	-	-	-	-	2051	9283	13062	14952
	end	25186	-	-	-	-	-	-	-	-	1846	10153	17353	20952
AG-PSK2S255FC21	start	40242	-	-	-	-	-	-	-	21437	25675	34152	42629	46867
	run	17175	-	-	-	-	-	-	-	7302	9527	13978	18428	20653
	end	25186	-	-	-	-	-	-	-	6381	10619	19096	27573	31812
AG-PSK2S285FC21	start	40242	-	-	-	-	-	-	27758	33052	38347	48935	59524	64819
	run	17175	-	-	-	-	-	-	10621	13400	16180	21739	27298	30078
	end	25186	-	-	-	-	-	-	12702	17996	23291	33879	44468	49763
AG-PSK2S300FC21	start	40242	-	-	-	-	-	27611	33477	39344	45210	56943	68676	74542
	run	17175	-	-	-	-	-	10544	13623	16703	19783	25943	32103	35182
	end	25186	-	-	-	-	-	12555	18422	24288	30154	41887	53620	59486
AG-PSK2S335FC21	start	40242	-	-	-	26019	33334	40649	47964	55279	62594	77224	91854	-
	run	17175	-	-	-	9708	13548	17389	21229	25069	28910	36591	44271	-
	end	25186	-	-	-	10963	18278	25593	32908	40223	47538	62168	76798	-
AG-PSK2S360FC21	start	40242	-	-	25499	33947	42394	50842	59289	67737	76185	-	-	-
	run	17175	-	-	9435	13870	18305	22740	27175	31610	36045	-	-	-
	end	25186	-	-	10443	18891	27338	35786	44234	52681	61129	-	-	-
AG-PSK2S385FC21	start	40242	-	23122	32783	42445	52106	61768	71430	81091	90753	-	-	-
	run	17175	-	8187	13259	18331	23404	28476	33548	38621	43693	-	-	-
	end	25186	-	8066	17727	27389	37051	46712	56374	66035	75697	-	-	-
AG-PSK2S435FC21	start	40242	24150	36484	48818	61152	73486	85820	-	-	-	-	-	-
	run	17175	8727	15202	21677	28153	34628	41103	-	-	-	-	-	-
	end	25186	9094	21428	33762	46096	58430	70764	-	-	-	-	-	-
AG-PSK2S485FC21	start	40242	36143	51476	66808	82141	-	-	-	-	-	-	-	-
	run	17175	15023	23073	31122	39172	-	-	-	-	-	-	-	-
	end	25186	21087	36420	51752	67085	-	-	-	-	-	-	-	-

Spring Return Symmetric Torque Data

K2, K3, & K4 Sizes w/ Various Spring Cartridges, Symmetric Yoke

K2 Size - Spring 22

Symmetric Yoke



Torques

Model	Pos.	Spring Torque in-lbs	40 PSI	50 PSI	60 PSI	70 PSI	80 PSI	90 PSI	100 PSI	110 PSI	120 PSI	140 PSI	160 PSI	170 PSI
AG-PSK2S285FC22	start	46347	-	-	-	-	-	-	23660	28955	34249	44838	55427	60721
	run	19853	-	-	-	-	-	-	7942	10722	13502	19061	24620	27399
	end	29284	-	-	-	-	-	-	6597	11891	17185	27774	38363	43657
AG-PSK2S300FC22	start	46347	-	-	-	-	-	-	29380	35246	41113	52846	64578	70445
	run	19853	-	-	-	-	-	-	10945	14025	17105	23265	29424	32504
	end	29284	-	-	-	-	-	-	12316	18183	24049	35782	47515	53381
AG-PSK2S335FC22	start	46347	-	-	-	21922	29237	36552	43867	51182	58497	73127	87757	-
	run	19853	-	-	-	7030	10870	14710	18551	22391	26232	33912	41593	-
	end	29284	-	-	-	4858	12173	19488	26803	34118	41433	56063	70693	-
AG-PSK2S360FC22	start	46347	-	-	-	29849	38297	46744	55192	63640	72087	-	-	-
	run	19853	-	-	-	11192	15627	20062	24497	28932	33367	-	-	-
	end	29284	-	-	-	12786	21233	29681	38128	46576	55024	-	-	-
AG-PSK2S385FC22	start	46347	-	-	28686	38347	48009	57671	67332	76994	86655	-	-	-
	run	19853	-	-	10581	15653	20726	25798	30870	35943	41015	-	-	-
	end	29284	-	-	11622	21284	30945	40607	50269	59930	69592	-	-	-
AG-PSK2S435FC22	start	46347	20053	32387	44721	57055	69389	81723	-	-	-	-	-	-
	run	19853	6048	12524	18999	25474	31950	38425	-	-	-	-	-	-
	end	29284	2989	15323	27657	39991	52325	64659	-	-	-	-	-	-
AG-PSK2S485FC22	start	46347	32046	47378	62711	78043	-	-	-	-	-	-	-	-
	run	19853	12345	20394	28444	36493	-	-	-	-	-	-	-	-
	end	29284	14982	30315	45647	60980	-	-	-	-	-	-	-	-

AG Series Technical Brochure

Max-Air Technology Inc. | Rotary Actuators & Valve Automation Solutions



maxairtech.com

K2 Size - Spring 03

Symmetric Yoke



Torques

Model	Pos.	Spring Torque in-lbs	40 PSI	50 PSI	60 PSI	70 PSI	80 PSI	90 PSI	100 PSI	110 PSI	120 PSI	140 PSI	160 PSI	170 PSI
AG-PSK2S285FC03	start	46761	-	-	-	-	-	-	-	27537	32831	43420	54009	59303
	run	20334	-	-	-	-	-	-	-	10241	13021	18580	24139	26918
	end	30702	-	-	-	-	-	-	-	11477	16771	27360	37949	43243
AG-PSK2S-300FC03	start	46761	-	-	-	-	-	-	27962	33828	39695	51428	63160	69027
	run	20334	-	-	-	-	-	-	10464	13544	16624	22784	28943	32023
	end	30702	-	-	-	-	-	-	11902	17769	23635	35368	47101	52967
AG-PSK2S-335FC03	start	46761	-	-	-	-	-	35134	42449	49764	57079	71709	86339	-
	run	20334	-	-	-	-	-	14230	18070	21910	25751	33431	41112	-
	end	30702	-	-	-	-	-	19074	26389	33704	41019	55649	70279	-
AG-PSK2S335FC03	start	46761	-	-	-	28431	36879	45327	53774	62222	70669	87564	-	-
	run	20334	-	-	-	10711	15146	19581	24016	28451	32886	41756	-	-
	end	30702	-	-	-	12372	20819	29267	37714	46162	54609	71505	-	-
AG-PSK2S385FC03	start	46761	-	-	27268	36929	46591	56253	65914	75576	85237	-	-	-
	run	20334	-	-	10100	15172	20245	25317	30389	35462	40534	-	-	-
	end	30702	-	-	11208	20870	30531	40193	49854	59516	69178	-	-	-
AG-PSK2S435FC03	start	46761	-	30969	43303	55637	67971	80305	-	-	-	-	-	-
	run	20334	-	12043	18518	24994	31469	37944	-	-	-	-	-	-
	end	30702	-	14909	27243	39577	51911	64245	-	-	-	-	-	-
AG-PSK2S485FC03	start	46761	30628	45960	61293	76625	-	-	-	-	-	-	-	-
	run	20334	11864	19914	27963	36013	-	-	-	-	-	-	-	-
	end	30702	14568	29901	45233	60565	-	-	-	-	-	-	-	-

Spring Return Symmetric Torque Data

K2, K3, & K4 Sizes w/ Various Spring Cartridges, Symmetric Yoke

K2 Size - Spring 31

Symmetric Yoke



Torques

Model	Pos.	Spring Torque in-lbs	40 PSI	50 PSI	60 PSI	70 PSI	80 PSI	90 PSI	100 PSI	110 PSI	120 PSI	140 PSI	160 PSI	170 PSI
AG-PSK2S300FC31	start	55924	-	-	-	-	-	-	22614	28480	34347	46080	57812	63679
	run	24143	-	-	-	-	-	-	6655	9735	12815	18975	25134	28214
	end	36050	-	-	-	-	-	-	2740	8606	14472	26205	37938	43804
AG-PSK2S335FC31	start	55924	-	-	-	-	-	29786	37101	44416	51731	66361	80991	88306
	run	24143	-	-	-	-	-	10420	14261	18101	21942	29622	37303	41144
	end	36050	-	-	-	-	-	9911	17226	24541	31856	46487	61117	68432
AG-PSK2S360FC31	start	55924	-	-	-	-	-	39978	48426	56874	65321	82216	-	-
	run	24143	-	-	-	-	-	15772	20207	24642	29077	37947	-	-
	end	36050	-	-	-	-	-	20104	28552	36999	45447	62342	-	-
AG-PSK2S385FC31	start	55924	-	-	-	31581	41243	50905	60566	70228	79889	-	-	-
	run	24143	-	-	-	11363	16436	21508	26580	31653	36725	-	-	-
	end	36050	-	-	-	11707	21369	31030	40692	50353	60015	-	-	-
AG-PSK2S435FC31	start	55924	-	-	37955	50289	62623	74957	87291	-	-	-	-	-
	run	24143	-	-	14709	21185	27660	34135	40611	-	-	-	-	-
	end	36050	-	-	18080	30414	42748	55082	67416	-	-	-	-	-
AG-PSK2S485FC31	start	55924	25280	40612	55945	71277	-	-	-	-	-	-	-	-
	run	24143	8055	16104	24154	32204	-	-	-	-	-	-	-	-
	end	36050	5406	20738	36070	51403	-	-	-	-	-	-	-	-

AG Series Technical Brochure

Max-Air Technology Inc. | Rotary Actuators & Valve Automation Solutions



maxairtech.com

K2 Size - Spring 32

Symmetric Yoke



Torques

Model	Pos.	Spring Torque in-lbs	40 PSI	50 PSI	60 PSI	70 PSI	80 PSI	90 PSI	100 PSI	110 PSI	120 PSI	140 PSI	160 PSI	170 PSI
AG-PSK2S335FC32	start	62028	-	-	-	-	-	-	33002	40317	47632	62262	76892	84207
	run	26821	-	-	-	-	-	-	11583	15423	19263	26944	34625	38465
	end	40148	-	-	-	-	-	-	11122	18437	25752	40383	55013	62328
AG-P SK2S360FC32	start	62028	-	-	-	-	-	35880	44327	52775	61223	78118	95013	-
	run	26821	-	-	-	-	-	13094	17528	21963	26398	35268	44138	-
	end	40148	-	-	-	-	-	14000	22448	30895	39343	56238	73133	-
AG-PSK2S385FC32	start	62028	-	-	-	27483	37144	46806	56468	66129	75791	-	-	-
	run	26821	-	-	-	8685	13757	18830	23902	28974	34047	-	-	-
	end	40148	-	-	-	5603	15265	24926	34588	44249	53911	-	-	-
AG-PSK2S435FC32	start	62028	-	-	33856	46190	58524	70858	83192	-	-	-	-	-
	run	26821	-	-	12031	18506	24982	31457	37932	-	-	-	-	-
	end	40148	-	-	11976	24310	36644	48978	61312	-	-	-	-	-
AG-PSK2S485FC32	start	62028	-	36514	51846	67179	82511	97843	-	-	-	-	-	-
	run	26821	-	13426	21476	29525	37575	45624	-	-	-	-	-	-
	end	40148	-	14634	29967	45299	60631	75964	-	-	-	-	-	-

Spring Return Symmetric Torque Data

K2, K3, & K4 Sizes w/ Various Spring Cartridges, Symmetric Yoke

K3 Size - Spring 01

Symmetric Yoke



Torques

Model	Pos.	Spring Torque in-lbs	40 PSI	50 PSI	60 PSI	70 PSI	80 PSI	90 PSI	100 PSI	110 PSI	120 PSI	140 PSI	160 PSI	170 PSI
AG-PSK3S285FC01	start	38391	-	-	-	24543	31083	37623	44164	50704	57244	70324	83404	89945
	run	15653	-	-	-	8382	11816	15250	18683	22117	25550	32417	39285	42718
	end	21238	-	-	-	7390	13930	20470	27010	33551	40091	53171	66251	72791
AG-PSK3S300FC01	start	38391	-	-	-	29489	36736	43982	51229	58476	65723	80216	94709	101956
	run	15653	-	-	-	10979	14784	18588	22393	26197	30002	37611	45220	49024
	end	21238	-	-	-	12336	19583	26829	34076	41323	48569	63063	77556	84803
AG-PSK3S335FC01	start	38391	-	-	32980	42016	51052	60088	69124	78161	87197	105269	123342	132378
	run	15653	-	-	12812	17556	22300	27044	31788	36532	41276	50764	60252	64996
	end	21238	-	-	15826	24863	33899	42935	51971	61008	70044	88116	106189	115225
AG-PSK3S360FC01	start	38391	-	30938	41374	51809	62244	72679	83115	93550	103985	124856	145726	-
	run	15653	-	11740	17218	22697	28175	33654	39132	44611	50089	61046	72003	-
	end	21238	-	13785	24220	34656	45091	55526	65961	76397	86832	107702	128573	-
AG-PSK3S385FC01	start	38391	26502	38437	50372	62307	74241	86176	98111	110046	121981	145851	-	-
	run	15653	9411	15677	21942	28208	34474	40740	47006	53272	59537	72069	-	-
	end	21238	9349	21284	33218	45153	57088	69023	80958	92893	104828	128698	-	-
AG-PSK3S435FC01	start	38391	39707	54943	70179	85415	100652	115888	131124	146360	161596	-	-	-
	run	15653	16343	24342	32341	40340	48339	56338	64337	72336	80335	-	-	-
	end	21238	22554	37790	53026	68262	83498	98735	113971	129207	144443	-	-	-
AG-PSK3S485FC01	start	38391	54522	73462	92402	111342	130283	149223	168163	-	-	-	-	-
	run	15653	24122	34065	44009	53952	63896	73839	83783	-	-	-	-	-
	end	21238	37369	56309	75249	94189	113129	132069	151009	-	-	-	-	-
AG-PSK3S535FC01	start	38391	70948	93995	117041	140088	-	-	-	-	-	-	-	-
	run	15653	32745	44845	56944	69043	-	-	-	-	-	-	-	-
	end	21238	53795	76842	99888	122935	-	-	-	-	-	-	-	-
AG-PSK3S585FC01	start	38391	88984	116540	144095	171651	-	-	-	-	-	-	-	-
	run	15653	42214	56681	71147	85614	-	-	-	-	-	-	-	-
	end	21238	71831	99387	126942	154498	-	-	-	-	-	-	-	-

AG Series Technical Brochure

Max-Air Technology Inc. | Rotary Actuators & Valve Automation Solutions



maxairtech.com

K3 Size - Spring 02

Symmetric Yoke



Torques

Model	Pos.	Spring Torque in-lbs	40 PSI	50 PSI	60 PSI	70 PSI	80 PSI	90 PSI	100 PSI	110 PSI	120 PSI	140 PSI	160 PSI	170 PSI
AG-PSK3S285FC02	start	57763	-	-	-	-	-	6803	29655	38685	45225	58305	71386	77926
	run	23893	-	-	-	-	-	2251	9813	13877	17310	24177	31045	34478
	end	33257	-	-	-	-	-	1773	7728	14179	20719	33799	46880	53420
AG-PSK3S300FC02	start	57763	-	-	-	-	-	8276	36073	46457	53704	68197	82690	89937
	run	23893	-	-	-	-	-	3024	13183	17957	21762	29371	36980	40784
	end	33257	-	-	-	-	-	3245	14146	21951	29198	43691	58184	65431
AG-PSK3S-335FC02	start	57763	-	-	-	29997	39033	48069	57106	66142	75178	93251	111323	120359
	run	23893	-	-	-	9316	14060	18804	23548	28292	33036	42524	52012	56756
	end	33257	-	-	-	5491	14527	23563	32600	41636	50672	68745	86817	95853
AG-PSK3S360FC02	start	57763	-	-	-	39790	50225	60661	71096	81531	91966	112837	133707	144142
	run	23893	-	-	-	14457	19935	25414	30892	36371	41849	52806	63763	69242
	end	33257	-	-	-	15284	25719	36155	46590	57025	67460	88331	109201	119636
AG-PSK3S385FC02	start	57763	-	-	38353	50288	62223	74158	86092	98027	109962	133832	157702	169637
	run	23893	-	-	13702	19968	26234	32500	38766	45032	51297	63829	76361	82626
	end	33257	-	-	13847	25782	37717	49651	61586	73521	85456	109326	133196	145131
AG-PSK3S435FC02	start	57763	17041	42924	58160	73397	88633	103869	119105	134341	149577	-	-	-
	run	23893	5628	16102	24101	32100	40099	48098	56097	64096	72095	-	-	-
	end	33257	4401	18418	33654	48891	64127	79363	94599	109835	125071	-	-	-
AG-PSK3S485FC02	start	57763	42504	61444	80384	99324	118264	137204	156144	-	-	-	-	-
	run	23893	15882	25825	35769	45712	55656	65599	75543	-	-	-	-	-
	end	33257	17998	36938	55878	74818	93758	112698	131638	-	-	-	-	-
AG-PSK3S535FC02	start	57763	58929	81976	105022	128069	151115	174162	-	-	-	-	-	-
	run	23893	24505	36605	48704	60803	72903	85002	-	-	-	-	-	-
	end	33257	34423	57470	80516	103563	126609	149656	-	-	-	-	-	-
AG-PSK3S585FC02	start	57763	76966	104521	132077	159632	-	-	-	-	-	-	-	-
	run	23893	33974	48441	62907	77374	-	-	-	-	-	-	-	-
	end	33257	52460	80015	107571	135126	-	-	-	-	-	-	-	-

Spring Return Symmetric Torque Data

K2, K3, & K4 Sizes w/ Various Spring Cartridges, Symmetric Yoke

K3 Size - Spring 21

Symmetric Yoke



Torques

Model	Pos.	Spring Torque in-lbs	40 PSI	50 PSI	60 PSI	70 PSI	80 PSI	90 PSI	100 PSI	110 PSI	120 PSI	140 PSI	160 PSI	170 PSI
AG-PSK3S285FC21	start	76623	-	-	-	-	-	-	-	-	-	48328	61408	67949
	run	31462	-	-	-	-	-	-	-	-	-	16608	23475	26908
	end	43234	-	-	-	-	-	-	-	-	-	14939	28019	34560
AG-PSK3S300FC21	start	76623	-	-	-	-	-	-	-	23865	43726	58220	72713	79960
	run	31462	-	-	-	-	-	-	-	7409	14192	21801	29410	33214
	end	43234	-	-	-	-	-	-	-	4359	10338	24831	39324	46571
AG-PSK3S335FC21	start	76623	-	-	-	-	-	9957	43402	56165	65201	83273	101346	110382
	run	31462	-	-	-	-	-	3428	14944	20722	25466	34954	44442	49186
	end	43234	-	-	-	-	-	3103	13528	22776	31812	49884	67957	76993
AG-PSK3S360FC21	start	76623	-	-	-	-	24540	50683	61119	71554	81989	102859	123730	134165
	run	31462	-	-	-	-	8363	17844	23323	28801	34280	45237	56194	61672
	end	43234	-	-	-	-	7318	17294	27730	38165	48600	69471	90341	100776
AG-PSK3S385FC21	start	76623	-	-	5928	35794	52245	64180	76115	88050	99985	123855	142528	41053
	run	31462	-	-	1913	11549	18664	24930	31196	37462	43727	56259	66340	19108
	end	43234	-	-	1359	8204	18856	30791	42726	54661	66596	90466	110194	31740
AG-PSK3S435FC21	start	76623	-	-	48183	63419	78656	93892	109128	124364	139600	-	-	-
	run	31462	-	-	16532	24531	32530	40529	48528	56527	64526	-	-	-
	end	43234	-	-	14794	30030	45267	60503	75739	90975	106211	-	-	-
AG-PSK3S485FC21	start	76623	20207	51466	70406	89346	108286	127226	146166	165107	184047	-	-	-
	run	31462	6088	18255	28199	38142	48086	58029	67973	77916	87860	-	-	-
	end	43234	2985	18077	37017	55957	74898	93838	112778	131718	150658	-	-	-
AG-PSK3S535FC21	start	76623	48952	71999	95045	118092	141138	164185	-	-	-	-	-	-
	run	31462	16935	29035	41134	53233	65333	77432	-	-	-	-	-	-
	end	43234	15563	38610	61656	84703	107749	130796	-	-	-	-	-	-
AG-PSK3S585FC21	start	76623	66988	94544	122099	149655	-	-	-	-	-	-	-	-
	run	31462	26404	40871	55338	69804	-	-	-	-	-	-	-	-
	end	43234	33599	61155	88711	116266	-	-	-	-	-	-	-	-

AG Series Technical Brochure

Max-Air Technology Inc. | Rotary Actuators & Valve Automation Solutions



maxairtech.com

K3 Size - Spring 30

Symmetric Yoke



Torques

Model	Pos.	Spring Torque in-lbs	40 PSI	50 PSI	60 PSI	70 PSI	80 PSI	90 PSI	100 PSI	110 PSI	120 PSI	140 PSI	160 PSI	170 PSI
AG-PSK3S285FC30	start	81116	-	-	-	-	-	-	-	-	-	29388	54815	61355
	run	34373	-	-	-	-	-	-	-	-	-	10069	20565	23998
	end	49827	-	-	-	-	-	-	-	-	-	8968	23526	30066
AG-PSK3S300FC30	start	81116	-	-	-	-	-	-	-	-	-	51627	66120	73367
	run	34373	-	-	-	-	-	-	-	-	-	18891	26500	30304
	end	49827	-	-	-	-	-	-	-	-	-	20337	34831	42078
AG-PSK3S335FC30	start	81116	-	-	-	-	-	8604	37503	49572	58608	76680	94753	103789
	run	34373	-	-	-	-	-	2831	12340	17812	22556	32044	41532	46276
	end	49827	-	-	-	-	-	2181	9507	18282	27318	45391	63463	72500
AG-PSK3S360FC30	start	81116	-	-	-	-	21139	44090	54525	64961	75396	96266	117137	127572
	run	34373	-	-	-	-	6862	14934	20412	25891	31369	42326	53283	58762
	end	49827	-	-	-	-	5000	12801	23236	33671	44107	64977	85848	96283
AG-PSK3S385FC30	start	81116	-	-	5026	30346	45652	57587	69522	81457	93392	117262	141131	153066
	run	34373	-	-	1514	9145	15754	22020	28286	34551	40817	53349	65881	72146
	end	49827	-	-	744	4491	14363	26298	38233	50168	62103	85972	109842	121777
AG-PSK3S435FC30	start	81116	-	-	41590	56826	72062	87299	102535	117771	133007	-	-	-
	run	34373	-	-	13621	21620	29619	37618	45617	53616	61615	-	-	-
	end	49827	-	-	10301	25537	40773	56009	71245	86482	101718	-	-	-
AG-PSK3S485FC30	start	81116	-	41444	63813	82753	101693	120633	139573	158513	177454	-	-	-
	run	34373	-	14409	25289	35232	45176	55119	65063	75006	84950	-	-	-
	end	49827	-	13448	32524	51464	70404	89344	108284	127224	146164	-	-	-
AG-PSK3S535FC30	start	81116	42359	65406	88452	111499	134545	157592	-	-	-	-	-	-
	run	34373	14025	26124	38224	50323	62423	74522	-	-	-	-	-	-
	end	49827	11070	34116	57163	80209	103256	126302	-	-	-	-	-	-
AG-PSK3S585FC30	start	81116	60395	87951	115506	143062	-	-	-	-	-	-	-	-
	run	34373	23494	37961	52427	66894	-	-	-	-	-	-	-	-
	end	49827	29106	56661	84217	111773	-	-	-	-	-	-	-	-

Spring Return Symmetric Torque Data

K2, K3, & K4 Sizes w/ Various Spring Cartridges, Symmetric Yoke

K3 Size - Spring 40

Symmetric Yoke



Torques

Model	Pos.	Spring Torque in-lbs	40 PSI	50 PSI	60 PSI	70 PSI	80 PSI	90 PSI	100 PSI	110 PSI	120 PSI	140 PSI	160 PSI	170 PSI
AG-PSK3S335FC40	start	92246	-	-	-	-	-	-	-	42686	51722	69794	87867	96903
	run	39102	-	-	-	-	-	-	-	13083	17827	27315	36803	41547
	end	56713	-	-	-	-	-	-	-	7153	16189	34261	52334	61370
AG-PSK3S360FC40	start	92246	-	-	-	-	-	-	47640	58075	68510	89380	110251	120686
	run	39102	-	-	-	-	-	-	15683	21162	26640	37597	48554	54033
	end	56713	-	-	-	-	-	-	12106	22542	32977	53847	74139	71943
AG-PSK3S385FC40	start	92246	-	-	-	-	-	50701	62636	74571	86506	110376	134246	146180
	run	39102	-	-	-	-	-	17291	23557	29822	36088	48620	61151	67417
	end	56713	-	-	-	-	-	15168	27103	39038	50973	74843	98712	110647
AG-PSK3S435FC40	start	92246	-	-	-	49940	65177	80413	95649	110885	126121	156594	-	-
	run	39102	-	-	-	16891	24890	32889	40888	48887	56886	72884	-	-
	end	56713	-	-	-	14407	29643	44880	60116	75352	90588	121060	-	-
AG-PSK3S485FC40	start	92246	-	-	56927	75867	94807	113747	132688	151628	170568	-	-	-
	run	39102	-	-	20559	30503	40446	50390	60334	70277	80221	-	-	-
	end	56713	-	-	21394	40334	59274	78214	97154	116094	135035	-	-	-
AG-PSK3S535FC40	start	92246	-	58520	81566	104613	127659	150706	-	-	-	-	-	-
	run	39102	-	21395	33495	45594	57694	69793	-	-	-	-	-	-
	end	56713	-	22987	46033	69080	92126	115173	-	-	-	-	-	-
AG-PSK3S585FC40	start	92246	53509	81065	108620	136176	-	-	-	-	-	-	-	-
	run	39102	18765	33232	47698	62165	-	-	-	-	-	-	-	-
	end	56713	17976	45532	73087	100643	-	-	-	-	-	-	-	-

AG Series Technical Brochure

Max-Air Technology Inc. | Rotary Actuators & Valve Automation Solutions



maxairtech.com

K3 Size - Spring 50

Symmetric Yoke



Torques

Model	Pos.	Spring Torque in-lbs	40 PSI	50 PSI	60 PSI	70 PSI	80 PSI	90 PSI	100 PSI	110 PSI	120 PSI	140 PSI	160 PSI	170 PSI
AG-PSK3S335FC50	start	103390	-	-	-	-	-	-	-	-	44253	62325	80398	89434
	run	43988	-	-	-	-	-	-	-	-	12941	22429	31917	36661
	end	64182	-	-	-	-	-	-	-	-	5044	23117	41189	50225
AG-PSK3S360FC50	start	103390	-	-	-	-	-	-	-	33241	61041	81912	102782	113217
	run	43988	-	-	-	-	-	-	-	11439	21754	32711	43668	49147
	end	64182	-	-	-	-	-	-	-	10335	21832	42703	63573	74009
AG-PSK3S385FC50	start	103390	-	-	-	-	-	11698	50991	67102	79037	102907	126777	138712
	run	43988	-	-	-	-	-	4029	17561	24936	31202	43734	56265	62531
	end	64182	-	-	-	-	-	3650	15909	27893	39828	63698	87568	99503
AG-PSK3S435FC50	start	103390	-	-	-	42472	57708	72944	88180	103416	118652	149125	-	-
	run	43988	-	-	-	12005	20004	28003	36002	44001	52000	67998	-	-
	end	64182	-	-	-	3263	18499	33735	48971	64207	79444	109916	-	-
AG-PSK3S485FC50	start	103390	-	-	49459	68399	87339	106279	125219	144159	163099	-	-	-
	run	43988	-	-	15673	25617	35560	45504	55448	65391	75335	-	-	-
	end	64182	-	-	10250	29190	48130	67070	86010	104950	123890	-	-	-
AG-PSK3S535FC50	start	103390	-	51051	74097	97144	120190	143237	166283	-	-	-	-	-
	run	43988	-	16509	28609	40708	52808	64907	77006	-	-	-	-	-
	end	64182	-	11842	34889	57935	80982	104028	127075	-	-	-	-	-
AG-PSK3S585FC50	start	103390	46041	73596	101152	128707	156263	183818	-	-	-	-	-	-
	run	43988	13879	28346	42812	57279	71746	86212	-	-	-	-	-	-
	end	64182	6832	34387	61943	89498	117054	144610	-	-	-	-	-	-

Spring Return Symmetric Torque Data

K2, K3, & K4 Sizes w/ Various Spring Cartridges, Symmetric Yoke

K3 Size - Spring 60

Symmetric Yoke



Torques

Model	Pos.	Spring Torque in-lbs	40 PSI	50 PSI	60 PSI	70 PSI	80 PSI	90 PSI	100 PSI	110 PSI	120 PSI	140 PSI	160 PSI	170 PSI
AG-PSK3S360FC60	start	110566	-	-	-	-	-	-	-	44510	54945	75815	96686	107121
	run	47472	-	-	-	-	-	-	-	12792	18270	29227	40184	45663
	end	70278	-	-	-	-	-	-	-	4221	14657	35527	56397	66833
AG-PSK3S385FC60	start	110566	-	-	-	-	-	-	49071	61006	72941	96811	120680	132615
	run	47472	-	-	-	-	-	-	15187	21452	27718	40250	52782	59047
	end	70278	-	-	-	-	-	-	8783	20718	32652	56522	80392	92327
AG-PSK3S435FC60	start	110566	-	-	-	-	-	66847	82084	97320	112556	143028	-	-
	run	47472	-	-	-	-	-	24519	32518	40517	48516	64514	-	-
	end	70278	-	-	-	-	-	26559	41795	57032	72268	102740	-	-
AG-PSK3S485FC60	start	110566	-	-	-	62302	81242	100182	119122	138062	157002	-	-	-
	run	47472	-	-	-	22133	32077	42020	51964	61907	71851	-	-	-
	end	70278	-	-	-	22014	40954	59894	78834	97774	116714	-	-	-
AG-PSK3S535FC60	start	110566	-	-	68001	91047	114094	137140	160187	-	-	-	-	-
	run	47472	-	-	25125	37224	49324	61423	73522	-	-	-	-	-
	end	70278	-	-	27713	50759	73806	96852	119899	-	-	-	-	-
AG-PSK3S585FC60	start	110566	-	67500	95055	122611	-	-	-	-	-	-	-	-
	run	47472	-	24862	39328	53795	-	-	-	-	-	-	-	-
	end	70278	-	27211	54767	82323	-	-	-	-	-	-	-	-

AG Series Technical Brochure

Max-Air Technology Inc. | Rotary Actuators & Valve Automation Solutions



maxairtech.com

Spring Return Symmetric Torque Data

K2, K3, & K4 Sizes w/ Various Spring Cartridges, Symmetric Yoke

K4 Size - Spring 01

Symmetric Yoke



Torques

Model	Pos.	Spring Torque in-lbs	40 PSI	50 PSI	60 PSI	70 PSI	80 PSI	90 PSI	100 PSI	110 PSI	120 PSI	140 PSI	160 PSI	170 PSI
AG-PSK4S335FC01	start	72542	-	-	-	-	-	67010	78628	90246	101864	125100	148336	159954
	run	28900	-	-	-	-	-	25995	32095	38194	44294	56493	68692	74791
	end	38021	-	-	-	-	-	32420	44184	55947	67710	91236	114763	126526
AG-PSK4S360FC01	start	72542	-	-	-	56365	69782	83199	96615	110032	123449	150282	177116	190533
	run	28900	-	-	-	20407	27451	34494	41538	48582	55626	69713	83801	90845
	end	38021	-	-	-	21642	35227	48811	62396	75980	89565	116733	143902	157487
AG-PSK4S385FC01	start	72542	-	-	54517	69862	85207	100552	115897	131242	146587	177276	207966	223311
	run	28900	-	-	19437	27493	35549	43605	51661	59717	67773	83885	99997	108053
	end	38021	-	-	19771	35308	50845	66381	81918	97455	112991	144065	175138	190675
AG-PSK4S435FC01	start	72542	-	60395	79984	99574	119163	138752	158342	177931	197520	236699	275878	295467
	run	28900	-	22522	32807	43091	53376	63660	73945	84229	94513	115082	135651	145935
	end	38021	-	25722	45557	65391	85225	105059	124894	144728	164562	204230	243899	263733
AG-PSK4S485FC01	start	72542	59854	84205	108557	132908	157260	181611	205963	230314	254666	303369	-	-
	run	28900	22238	35023	47808	60592	73377	86161	98946	111730	124515	150084	-	-
	end	38021	25175	49831	74486	99142	123798	148454	173110	197766	222422	271733	-	-
AG-PSK4S535FC01	start	72542	80973	110604	140235	169867	199498	229129	258760	288391	318023	-	-	-
	run	28900	33326	48882	64439	79995	95551	111108	126664	142221	157777	-	-	-
	end	38021	46558	76559	106561	136562	166564	196566	226567	256569	286570	-	-	-
AG-PSK4S585FC01	start	72542	104162	139591	175019	210448	245877	281305	316734	-	-	-	-	-
	run	28900	45500	64100	82700	101300	119900	138500	157100	-	-	-	-	-
	end	38021	70037	105908	141780	177651	213523	249394	285265	-	-	-	-	-
AG-PSK4S635FC01	start	72542	129422	171166	212909	254653	296396	338140	-	-	-	-	-	-
	run	28900	58762	80677	102592	124508	146423	168339	-	-	-	-	-	-
	end	38021	95613	137878	180143	222409	264674	306939	-	-	-	-	-	-
AG-PSK4S685FC01	start	72542	156753	205329	253905	302481	-	-	-	-	-	-	-	-
	run	28900	73110	98613	124115	149618	-	-	-	-	-	-	-	-
	end	38021	123285	172468	221651	270835	-	-	-	-	-	-	-	-

AG Series Technical Brochure

Max-Air Technology Inc. | Rotary Actuators & Valve Automation Solutions



maxairtech.com

K4 Size - Spring 11

Symmetric Yoke



Torques

Model	Pos.	Spring Torque in-lbs	40 PSI	50 PSI	60 PSI	70 PSI	80 PSI	90 PSI	100 PSI	110 PSI	120 PSI	140 PSI	160 PSI	170 PSI
AG-PSK4S335FC11	start	89965	-	-	-	-	-	-	71839	83457	95075	118311	141547	153165
	run	35255	-	-	-	-	-	-	25739	31839	37938	50137	62336	68435
	end	44895	-	-	-	-	-	-	26543	38306	50069	73596	97122	108885
AG-PSK4S360FC11	start	89965	-	-	-	-	-	-	89826	103243	116660	143493	170327	183743
	run	35255	-	-	-	-	-	-	35183	42226	49270	63358	77445	84489
	end	44895	-	-	-	-	-	-	44755	58340	71924	99093	126262	139846
AG-PSK4S385FC11	start	89965	-	-	-	63073	78418	93763	109108	124453	139797	170487	201177	216522
	run	35255	-	-	-	21137	29193	37249	45305	53361	61417	77530	93642	101698
	end	44895	-	-	-	17667	33204	48741	64277	79814	95351	126424	157498	173034
AG-PSK4S435FC11	start	89965	-	-	-	92785	112374	131963	151553	171142	190731	229910	269089	288678
	run	35255	-	-	-	36736	47020	57304	67589	77873	88158	108727	129295	139580
	end	44895	-	-	-	47750	67585	87419	107253	127087	146921	186590	226258	246093
AG-PSK4S485FC11	start	89965	-	-	101768	126119	150471	174822	199174	223525	247877	296580	345283	-
	run	35255	-	-	41452	54236	67021	79805	92590	105374	118159	143728	169297	-
	end	44895	-	-	56846	81502	106158	130813	155469	180125	204781	254093	303405	-
AG-PSK4S535FC11	start	89965	74184	103815	133446	163077	192709	222340	251971	281602	311233	-	-	-
	run	35255	26970	42527	58083	73639	89196	104752	120309	135865	151421	-	-	-
	end	44895	28917	58919	88920	118922	148923	178925	208927	238928	268930	-	-	-
AG-PSK4S585FC11	start	89965	97373	132802	168230	203659	239087	274516	309945	-	-	-	-	-
	run	35255	39145	57745	76345	94945	113545	132145	150745	-	-	-	-	-
	end	44895	52396	88268	124139	160011	195882	231753	267625	-	-	-	-	-
AG-PSK4S635FC11	start	89965	122633	164377	206120	247864	289607	331351	-	-	-	-	-	-
	run	35255	52406	74322	96237	118152	140068	161983	-	-	-	-	-	-
	end	44895	77972	120237	162503	204768	247033	289299	-	-	-	-	-	-
AG-PSK4S685FC11	start	89965	149964	198540	247116	295692	-	-	-	-	-	-	-	-
	run	35255	66755	92257	117760	143262	-	-	-	-	-	-	-	-
	end	44895	105644	154827	204011	253194	-	-	-	-	-	-	-	-

Spring Return Symmetric Torque Data

K2, K3, & K4 Sizes w/ Various Spring Cartridges, Symmetric Yoke

K4 Size - Spring 02

Symmetric Yoke



Torques

Model	Pos.	Spring Torque in-lbs	40 PSI	50 PSI	60 PSI	70 PSI	80 PSI	90 PSI	100 PSI	110 PSI	120 PSI	140 PSI	160 PSI	170 PSI
AG-PSK4S335FC02	start	101180	-	-	-	-	-	-	-	47748	86341	109577	132813	144431
	run	40492	-	-	-	-	-	-	-	17690	32702	44900	57099	63199
	end	53738	-	-	-	-	-	-	-	19889	38714	62241	85767	97530
AG-PSK4S360FC02	start	101180	-	-	-	-	-	-	81092	94509	107926	134759	161593	175010
	run	40492	-	-	-	-	-	-	29946	36990	44034	58121	72209	79252
	end	53738	-	-	-	-	-	-	33400	46984	60569	87738	114906	128491
AG-PSK4S385FC02	start	101180	-	-	-	-	-	85029	100374	115719	131064	161753	192443	207788
	run	40492	-	-	-	-	-	32013	40069	48125	56181	72293	88405	96461
	end	53738	-	-	-	-	-	37386	52922	68459	83996	115069	146142	161679
AG-PSK4S435FC02	start	101180	-	-	-	84051	103640	123229	142819	162408	181997	221176	260355	279944
	run	40492	-	-	-	31499	41783	52068	62352	72637	82921	103490	124059	134343
	end	53738	-	-	-	36395	56229	76063	95898	115732	135566	175235	214903	234737
AG-PSK4S485FC02	start	101180	-	-	93034	117385	141737	166088	190440	214791	239143	287846	336549	-
	run	40492	-	-	36215	49000	61784	74569	87353	100138	112922	138491	164060	-
	end	53738	-	-	45491	70146	94802	119458	144114	168770	193426	242737	292049	-
AG-PSK4S535FC02	start	101180	65450	95081	124712	154344	183975	213606	243237	272868	302500	-	-	-
	run	40492	21734	37290	52846	68403	83959	99516	115072	130628	146185	-	-	-
	end	53738	17562	47563	77565	107567	137568	167570	197571	227573	257574	-	-	-
AG-PSK4S585FC02	start	101180	88639	124068	159496	194925	230354	265782	301211	-	-	-	-	-
	run	40492	33908	52508	71108	89708	108308	126908	145508	-	-	-	-	-
	end	53738	41041	76912	112784	148655	184527	220398	256270	-	-	-	-	-
AG-PSK4S635FC02	start	101180	113899	155643	197386	239130	280873	322617	-	-	-	-	-	-
	run	40492	47170	69085	91000	112916	134831	156746	-	-	-	-	-	-
	end	53738	66617	108882	151147	193413	235678	277943	-	-	-	-	-	-
AG-PSK4S685FC02	start	101180	141230	189806	238382	286958	-	-	-	-	-	-	-	-
	run	40492	61518	87020	112523	138025	-	-	-	-	-	-	-	-
	end	53738	94289	143472	192655	241839	-	-	-	-	-	-	-	-

AG Series Technical Brochure

Max-Air Technology Inc. | Rotary Actuators & Valve Automation Solutions



maxairtech.com

K4 Size - Spring 21

Symmetric Yoke



Torques

Model	Pos.	Spring Torque in-lbs	40 PSI	50 PSI	60 PSI	70 PSI	80 PSI	90 PSI	100 PSI	110 PSI	120 PSI	140 PSI	160 PSI	170 PSI
AG-PSK4S335FC21	start	132931	-	-	-	-	-	-	-	-	-	94536	117772	129390
	run	52775	-	-	-	-	-	-	-	-	-	32617	44816	50916
	end	68967	-	-	-	-	-	-	-	-	-	30092	53619	65382
AG-PSK4S360FC21	start	132931	-	-	-	-	-	-	-	-	-	119718	146552	159969
	run	52775	-	-	-	-	-	-	-	-	-	45838	59926	66970
	end	68967	-	-	-	-	-	-	-	-	-	55589	82758	96343
AG-PSK4S385FC21	start	132931	-	-	-	-	-	-	85333	100678	116023	146712	177402	192747
	run	52775	-	-	-	-	-	-	27786	35842	43898	60010	76122	84178
	end	68967	-	-	-	-	-	-	20774	36311	51847	82921	113994	129531
AG-PSK4S435FC21	start	132931	-	-	-	-	-	108188	127778	147367	166956	206135	245314	264903
	run	52775	-	-	-	-	-	39785	50069	60354	70638	91207	111776	122060
	end	68967	-	-	-	-	-	43915	63750	83584	103418	143086	182755	202589
AG-PSK4S485FC21	start	132931	-	-	-	102344	126696	151047	175399	199750	224102	272805	321508	-
	run	52775	-	-	-	36717	49501	62286	75070	87855	100639	126208	151778	-
	end	68967	-	-	-	37998	62654	87310	111966	136622	161278	210589	259901	-
AG-PSK4S535FC21	start	132931	-	-	109671	139303	168934	198565	228196	257827	287459	-	-	-
	run	52775	-	-	40563	56120	71676	87233	102789	118345	133902	-	-	-
	end	68967	-	-	45417	75418	105420	135422	165423	195425	225426	-	-	-
AG-PSK4S585FC21	start	132931	-	109027	144455	179884	215313	250741	286170	321598	357027	-	-	-
	run	52775	-	40225	58825	77425	96025	114625	133225	151825	170425	-	-	-
	end	68967	-	44764	80636	116507	152379	188250	224121	259993	295864	-	-	-
AG-PSK4S635FC21	start	132931	98858	140602	182345	224089	265832	307576	-	-	-	-	-	-
	run	52775	34887	56802	78717	100633	122548	144463	-	-	-	-	-	-
	end	68967	34469	76734	118999	161265	203530	245795	-	-	-	-	-	-
AG-PSK4S685FC21	start	132931	126189	174765	223341	271917	-	-	-	-	-	-	-	-
	run	52775	49235	74738	100240	125742	-	-	-	-	-	-	-	-
	end	68967	62141	111324	160507	209691	-	-	-	-	-	-	-	-

Spring Return Symmetric Torque Data

K2, K3, & K4 Sizes w/ Various Spring Cartridges, Symmetric Yoke

K4 Size - Spring 22

Symmetric Yoke



Torques

Model	Pos.	Spring Torque in-lbs	40 PSI	50 PSI	60 PSI	70 PSI	80 PSI	90 PSI	100 PSI	110 PSI	120 PSI	140 PSI	160 PSI	170 PSI
AG-PSK4S385FC22	start	142158	-	-	-	-	-	-	-	93223	108568	139257	169947	185292
	run	57154	-	-	-	-	-	-	-	31463	39519	55631	71743	79799
	end	76515	-	-	-	-	-	-	-	26968	42505	73578	104652	120188
AG-PSK4S435FC22	start	142158	-	-	-	-	-	100733	120323	139912	159502	198680	237859	257448
	run	57154	-	-	-	-	-	35406	45690	55975	66259	86828	107397	117681
	end	76515	-	-	-	-	-	34573	54407	74241	94076	133744	172480	171955
AG-PSK4S485FC22	start	142158	-	-	-	94890	119241	143592	167944	192295	216647	265350	314053	338404
	run	57154	-	-	-	32338	45122	57907	70691	83476	96260	121829	147398	160183
	end	76515	-	-	-	28656	53312	77968	102623	127279	151935	201247	250559	275215
AG-PSK4S535FC22	start	142158	-	-	102216	131848	161479	191110	220741	250372	280004	-	-	-
	run	57154	-	-	36184	51741	67297	82854	98410	113966	129523	-	-	-
	end	76515	-	-	36074	66076	96078	126079	156081	186082	216084	-	-	-
AG-PSK4S585FC22	start	142158	-	101572	137001	172429	207858	243286	278715	314143	349572	-	-	-
	run	57154	-	35846	54446	73046	91646	110246	128846	147446	166046	-	-	-
	end	76515	-	35422	71293	107165	143036	178908	214779	250650	286522	-	-	-
AG-PSK4S635FC22	start	142158	91403	133147	174890	216634	258377	300121	-	-	-	-	-	-
	run	57154	30508	52423	74338	96254	118169	140084	-	-	-	-	-	-
	end	76515	25126	67391	109657	151922	194187	236453	-	-	-	-	-	-
AG-PSK4S685FC22	start	142158	118734	167310	215886	264462	-	-	-	-	-	-	-	-
	run	57154	44856	70358	95861	121363	-	-	-	-	-	-	-	-
	end	76515	52798	101981	151165	200348	-	-	-	-	-	-	-	-

AG Series Technical Brochure

Max-Air Technology Inc. | Rotary Actuators & Valve Automation Solutions



maxairtech.com

K4 Size - Spring 03

Symmetric Yoke



Torques

Model	Pos.	Spring Torque in-lbs	40 PSI	50 PSI	60 PSI	70 PSI	80 PSI	90 PSI	100 PSI	110 PSI	120 PSI	140 PSI	160 PSI	170 PSI
AG-PSK4S385FC03	start	154592	-	-	-	-	-	-	-	79523	94868	125557	156247	171592
	run	64014	-	-	-	-	-	-	-	24603	32659	48771	64883	72939
	end	90387	-	-	-	-	-	-	-	14379	29915	60989	92062	107599
AG-PSK4S435FC03	start	154592	-	-	-	-	-	87033	106623	126212	145801	184980	224159	243748
	run	64014	-	-	-	-	-	28546	38830	49114	59399	79968	100537	110821
	end	90387	-	-	-	-	-	21983	41818	61652	81486	121154	160823	180657
AG-PSK4S485FC03	start	154592	-	-	-	81189	105541	129892	154244	178595	202947	251650	300353	324704
	run	64014	-	-	-	25478	38262	51047	63831	76616	89400	114969	140538	153323
	end	90387	-	-	-	16066	40722	65378	90034	114690	139346	188657	237969	262625
AG-PSK4S535FC03	start	154592	-	-	88516	118148	147779	177410	207041	236672	266304	-	-	-
	run	64014	-	-	29324	44881	60437	75993	91550	107106	122662	-	-	-
	end	90387	-	-	23485	53486	83488	113490	143491	173493	203494	-	-	-
AG-PSK4S585FC03	start	154592	-	87872	123300	158729	194158	229586	265015	300443	335872	-	-	-
	run	64014	-	28986	47586	66186	84786	103386	121986	140586	159186	-	-	-
	end	90387	-	25570	58704	94575	130447	166318	202189	238061	273932	-	-	-
AG-PSK4S635FC03	start	154592	77703	mote	161190	202934	244677	286421	328164	-	-	-	-	-
	run	64014	23647	45563	67478	89393	111309	133224	155139	-	-	-	-	-
	end	90387	12537	54802	97067	139333	181598	223863	266128	-	-	-	-	-
AG-PSK4S685FC03	start	154592	105034	153610	202186	250762	299338	347914	-	-	-	-	-	-
	run	64014	37996	63498	89001	114503	140006	165508	-	-	-	-	-	-
	end	90387	40209	89392	138575	187759	236942	286125	-	-	-	-	-	-

Spring Return Symmetric Torque Data

K2, K3, & K4 Sizes w/ Various Spring Cartridges, Symmetric Yoke

K4 Size - Spring 31

Symmetric Yoke



Torques

Model	Pos.	Spring Torque in-lbs	40 PSI	50 PSI	60 PSI	70 PSI	80 PSI	90 PSI	100 PSI	110 PSI	120 PSI	140 PSI	160 PSI	170 PSI
AG-PSK4S435FC31	start	171321	n/a	n/a	n/a	n/a	n/a	n/a	93692	113281	132870	172049	211228	230817
	run	71800	n/a	n/a	n/a	n/a	n/a	n/a	31044	41329	51613	72182	92751	103035
	end	103479	n/a	n/a	n/a	n/a	n/a	n/a	24880	44714	64548	104216	143885	163719
AG-PSK4S485FC31	start	171321	n/a	n/a	n/a	n/a	n/a	116961	141313	165664	190016	238719	287422	311773
	run	71800	n/a	n/a	n/a	n/a	n/a	43261	56045	68830	81614	107183	132753	145537
	end	103479	n/a	n/a	n/a	n/a	n/a	48440	73096	97752	122408	171719	221031	245687
AG-PSK4S535FC31	start	171321	n/a	n/a	n/a	105216	134848	164479	194110	223741	253372	312635	n/a	n/a
	run	71800	n/a	n/a	n/a	37095	52651	68208	83764	99320	114877	145989	n/a	n/a
	end	103479	n/a	n/a	n/a	36548	66550	96552	126553	156555	186556	246560	n/a	n/a
AG-PSK4S585FC31	start	171321	n/a	n/a	110369	145798	181226	216655	252084	287512	322941	n/a	n/a	n/a
	run	71800	n/a	n/a	39800	58400	77000	95600	114200	132800	151400	n/a	n/a	n/a
	end	103479	n/a	n/a	41766	77637	113509	149380	185251	221123	256994	n/a	n/a	n/a
AG-PSK4S635FC31	start	171321	n/a	106516	148259	190003	231746	273490	315233	n/a	n/a	n/a	n/a	n/a
	run	71800	n/a	37777	59692	81608	103523	125438	147354	n/a	n/a	n/a	n/a	n/a
	end	103479	n/a	37864	80129	122395	164660	206925	249190	n/a	n/a	n/a	n/a	n/a
AG-PSK4S685FC31	start	171321	92103	140679	189255	237831	286407	334983	n/a	n/a	n/a	n/a	n/a	n/a
	run	71800	30210	55712	81215	106717	132220	157722	n/a	n/a	n/a	n/a	n/a	n/a
	end	103479	23271	72454	121637	170821	220004	269187	n/a	n/a	n/a	n/a	n/a	n/a

AG Series Technical Brochure

Max-Air Technology Inc. | Rotary Actuators & Valve Automation Solutions



maxairtech.com

K4 Size - Spring 04

Symmetric Yoke



Torques

Model	Pos.	Spring Torque in-lbs	40 PSI	50 PSI	60 PSI	70 PSI	80 PSI	90 PSI	100 PSI	110 PSI	120 PSI	140 PSI	160 PSI	170 PSI
AG-PSK4S485FC04	start	134094	n/a	n/a	n/a	61685	86036	110388	134739	159091	183442	232145	280848	305200
	run	63753	n/a	n/a	n/a	25738	38523	51308	64092	76877	89661	115230	140799	153584
	end	110135	n/a	n/a	n/a	36821	61477	86133	110789	135445	160100	209412	258724	283380
AG-PSK4S535FC04	start	134094	n/a	n/a	69012	98643	128274	157905	187537	217168	246799	306061	n/a	n/a
	run	63753	n/a	n/a	29585	45142	60698	76254	91811	107367	122923	154036	n/a	n/a
	end	110135	n/a	n/a	44240	74241	104243	134244	164246	194248	224249	284252	n/a	n/a
AG-PSK4S585FC04	start	134094	32939	68367	103796	139224	174653	210082	245510	280939	316367	n/a	n/a	n/a
	run	63753	10647	29247	47847	66447	85047	103647	122247	140847	159447	n/a	n/a	n/a
	end	110135	7716	43587	79459	115330	151201	187073	222944	258816	294687	n/a	n/a	n/a
AG-PSK4S635FC04	start	134094	58199	99942	141686	183429	225173	266916	308660	n/a	n/a	n/a	n/a	n/a
	run	63753	23908	45824	67739	89654	111570	133485	155400	n/a	n/a	n/a	n/a	n/a
	end	110135	33291	75557	117822	160087	202353	244618	286883	n/a	n/a	n/a	n/a	n/a
AG-PSK4S685FC04	start	134094	85529	134105	182681	231257	279834	328410	n/a	n/a	n/a	n/a	n/a	n/a
	run	63753	38257	63759	89262	114764	140267	165769	n/a	n/a	n/a	n/a	n/a	n/a
	end	110135	60963	110147	159330	208513	257697	306880	n/a	n/a	n/a	n/a	n/a	n/a

Double Acting Canted Torque Data

K2, K3, & K4 Sizes, Double Acting, Canted Yoke

K2 Size - Double Acting

Canted Yoke

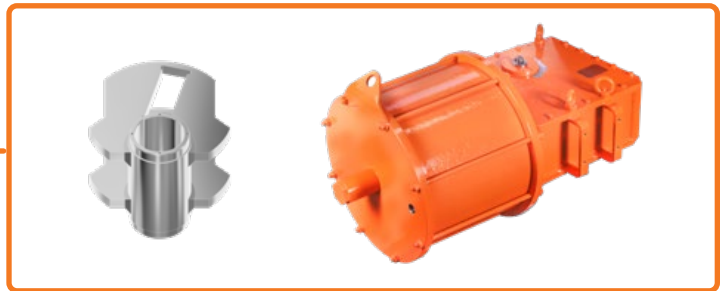

Torques

Model	Pos.	40 PSI	50 PSI	60 PSI	70 PSI	80 PSI	90 PSI	100 PSI	110 PSI	120 PSI	140 PSI	160 PSI	170 PSI
AG-PSK2S235DA	start	22343	27928	33514	39100	44685	50271	55857	61442	67028	78199	89370	94956
	run	7199	8999	10799	12599	14399	16199	17998	19798	21598	25198	28797	30597
	end	10841	13552	16262	18972	21683	24393	27103	29814	32524	37945	43365	46076
AG-PSK2S255DA	start	26307	32884	39461	46038	52615	59192	65769	72345	78922	92076	101613	n/a
	run	8477	10596	12715	14835	16954	19073	21192	23311	25431	29669	32742	n/a
	end	12765	15956	19148	22339	25530	28722	31913	35104	38296	44678	49306	n/a
AG-PSK2S285DA	start	32862	41077	49292	57508	65723	73938	82154	90369	69234	n/a	n/a	n/a
	run	10589	13236	15883	18530	21178	23825	26472	29119	22309	n/a	n/a	n/a
	end	15945	19932	23918	27905	31891	35877	39864	43850	33595	n/a	n/a	n/a
AG-PSK2S300DA	start	36412	45515	54617	63720	72823	81926	91029	n/a	n/a	n/a	n/a	n/a
	run	11733	14666	17599	20532	23465	26399	29332	n/a	n/a	n/a	n/a	n/a
	end	17668	22085	26502	30919	35336	39753	44170	n/a	n/a	n/a	n/a	n/a
AG-PSK2S335DA	start	45403	56754	68105	79456	90807	78502	n/a	n/a	n/a	n/a	n/a	n/a
	run	14630	18288	21945	25603	29260	25295	n/a	n/a	n/a	n/a	n/a	n/a
	end	22031	27539	33047	38554	44062	38092	n/a	n/a	n/a	n/a	n/a	n/a
AG-PSK2S360DA	start	52433	65541	78649	91757	n/a	n/a	n/a	n/a	n/a	n/a	n/a	n/a
	run	16895	21119	25343	29566	n/a	n/a	n/a	n/a	n/a	n/a	n/a	n/a
	end	25442	31803	38163	44524	n/a	n/a	n/a	n/a	n/a	n/a	n/a	n/a
AG-PSK2S385DA	start	59968	74960	75074	n/a	n/a	n/a	n/a	n/a	n/a	n/a	n/a	n/a
	run	19323	24154	24191	n/a	n/a	n/a	n/a	n/a	n/a	n/a	n/a	n/a
	end	29098	36373	36428	n/a	n/a	n/a	n/a	n/a	n/a	n/a	n/a	n/a
AG-PSK2S435DA	start	76556	95694	n/a	n/a	n/a	n/a	n/a	n/a	n/a	n/a	n/a	n/a
	run	24668	30835	n/a	n/a	n/a	n/a	n/a	n/a	n/a	n/a	n/a	n/a
	end	37147	46434	n/a	n/a	n/a	n/a	n/a	n/a	n/a	n/a	n/a	n/a
AG-PSK2S485DA	start	n/a	n/a	n/a	n/a	n/a	n/a	n/a	n/a	n/a	n/a	n/a	n/a
	run	n/a	n/a	n/a	n/a	n/a	n/a	n/a	n/a	n/a	n/a	n/a	n/a
	end	n/a	n/a	n/a	n/a	n/a	n/a	n/a	n/a	n/a	n/a	n/a	n/a

AG Series Technical Brochure

Max-Air Technology Inc. | Rotary Actuators & Valve Automation Solutions



maxairtech.com

Spring Return Canted Torque Data

K2, K3, & K4 Sizes w/ Various Spring Cartridges, Canted Yoke

K2 Size - Spring 01

Canted Yoke

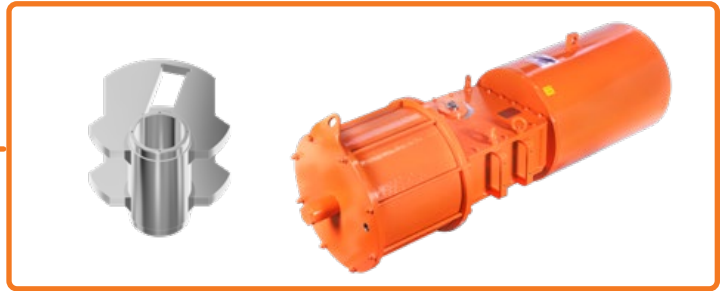

Torques

Model	Pos.	Spring Torque in-lbs	40 PSI	50 PSI	60 PSI	70 PSI	80 PSI	90 PSI	100 PSI	110 PSI	120 PSI	140 PSI	160 PSI	170 PSI
AG-PSK2S235FC01	start	11496	n/a	n/a	18855	24441	30027	35612	41198	46784	52369	63541	74712	80298
	run	6414	n/a	n/a	4385	6185	7985	9784	11584	13384	15184	18784	22383	24183
	end	14658	n/a	n/a	4766	7477	10187	12897	15608	18318	21028	26449	31870	34580
AG-PSK2S255FC01	start	11496	n/a	16757	24803	31380	37956	44533	51110	57687	64264	77418	90571	97148
	run	6414	n/a	3887	6301	8421	10540	12659	14778	16897	19017	23255	27494	29613
	end	14658	n/a	4209	7652	10843	14035	17226	20417	23609	26800	33182	39565	42756
AG-PSK2S285FC01	start	11496	n/a	26418	34634	42849	51065	59280	67495	75711	83926	100357	n/a	n/a
	run	6414	n/a	6822	9469	12116	14764	17411	20058	22705	25352	30647	n/a	n/a
	end	14658	n/a	8436	12422	16409	20395	24382	28368	32354	36341	44313	n/a	n/a
AG-PSK2S300FC01	start	11496	21753	30856	39959	49062	58165	67268	76371	85474	94577	36183	n/a	n/a
	run	6414	5319	8252	11185	14118	17051	19985	22918	25851	28784	11072	n/a	n/a
	end	14658	6172	10589	15006	19423	23840	28258	32675	37092	41509	16035	n/a	n/a
AG-PSK2S335FC01	start	11496	30745	42096	53447	64797	76148	87499	98850	41820	n/a	n/a	n/a	n/a
	run	6414	8216	11874	15531	19189	22846	26504	30161	12773	n/a	n/a	n/a	n/a
	end	14658	10535	16043	21551	27059	32567	38074	43582	18470	n/a	n/a	n/a	n/a
AG-PSK2S360FC01	start	11496	37774	50883	63991	77099	90207	79006	10464	n/a	n/a	n/a	n/a	n/a
	run	6414	10481	14705	18929	23152	27376	24114	3194	n/a	n/a	n/a	n/a	n/a
	end	14658	13946	20307	26667	33028	39388	34853	4616	n/a	n/a	n/a	n/a	n/a
AG-PSK2S385FC01	start	11496	45310	60302	75294	90286	15809	n/a	n/a	n/a	n/a	n/a	n/a	n/a
	run	6414	12909	17740	22571	27402	4810	n/a	n/a	n/a	n/a	n/a	n/a	n/a
	end	14658	17603	24877	32152	39426	6934	n/a	n/a	n/a	n/a	n/a	n/a	n/a
AG-PSK2S435FC01	start	11496	61897	81036	83187	16738	n/a	n/a	n/a	n/a	n/a	n/a	n/a	n/a
	run	6414	18254	24421	25346	5100	n/a	n/a	n/a	n/a	n/a	n/a	n/a	n/a
	end	14658	25651	34938	36582	7361	n/a	n/a	n/a	n/a	n/a	n/a	n/a	n/a
AG-PSK2S485FC01	start	11496	80507	104299	n/a	n/a	n/a	n/a	n/a	n/a	n/a	n/a	n/a	n/a
	run	6414	24251	31917	n/a	n/a	n/a	n/a	n/a	n/a	n/a	n/a	n/a	n/a
	end	14658	34682	46226	n/a	n/a	n/a	n/a	n/a	n/a	n/a	n/a	n/a	n/a

AG Series Technical Brochure

Max-Air Technology Inc. | Rotary Actuators & Valve Automation Solutions



maxairtech.com

K2 Size - Spring 11

Canted Yoke

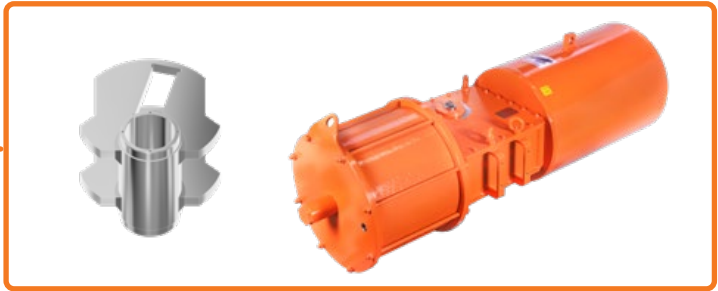

Torques

Model	Pos.	Spring Torque in-lbs	40 PSI	50 PSI	60 PSI	70 PSI	80 PSI	90 PSI	100 PSI	110 PSI	120 PSI	140 PSI	160 PSI	170 PSI
AG-PSK2S235FC11	start	18004	n/a	n/a	n/a	n/a	n/a	26561	32147	37732	43318	54489	65661	71246
	run	10147	n/a	n/a	n/a	n/a	n/a	6052	7851	9651	11451	15051	18650	20450
	end	23710	n/a	n/a	n/a	n/a	n/a	6389	9099	11810	14520	19941	25361	28072
AG-PSK2S255FC11	start	18004	n/a	n/a	n/a	19819	28905	35482	42059	48636	55212	68366	81520	88097
	run	10147	n/a	n/a	n/a	4315	6807	8926	11045	13165	15284	19522	23761	25880
	end	23710	n/a	n/a	n/a	4246	7526	10718	13909	17100	20292	26674	33057	36248
AG-PSK2S285FC11	start	18004	n/a	n/a	25582	33798	42013	50229	58444	66659	74875	91306	n/a	n/a
	run	10147	n/a	n/a	5736	8383	11031	13678	16325	18972	21619	26914	n/a	n/a
	end	23710	n/a	n/a	5914	9901	13887	17873	21860	25846	29832	37805	n/a	n/a
AG-PSK2S300FC11	start	18004	n/a	20131	30908	40011	49114	58216	67319	76422	85525	n/a	n/a	n/a
	run	10147	n/a	4244	7452	10385	13319	16252	19185	22118	25051	n/a	n/a	n/a
	end	23710	n/a	3953	8498	12915	17332	21749	26166	30583	35000	n/a	n/a	n/a
AG-PSK2S335FC11	start	18004	n/a	33044	44395	55746	67097	78448	89798	101149	78437	n/a	n/a	n/a
	run	10147	n/a	8141	11798	15456	19113	22771	26428	30086	23453	n/a	n/a	n/a
	end	23710	n/a	9535	15043	20551	26058	31566	37074	42582	33340	n/a	n/a	n/a
AG-PSK2S360FC11	start	18004	28723	41831	54939	68048	81156	71813	n/a	n/a	n/a	n/a	n/a	n/a
	run	10147	6748	10972	15196	19420	23643	21147	n/a	n/a	n/a	n/a	n/a	n/a
	end	23710	7438	13799	20159	26520	32880	29681	n/a	n/a	n/a	n/a	n/a	n/a
AG-PSK2S385FC11	start	18004	36258	51250	66242	81234	96226	n/a	n/a	n/a	n/a	n/a	n/a	n/a
	run	10147	9176	14007	18838	23669	28499	n/a	n/a	n/a	n/a	n/a	n/a	n/a
	end	23710	11094	18369	25644	32918	40193	n/a	n/a	n/a	n/a	n/a	n/a	n/a
AG-PSK2S435FC11	start	18004	52846	71985	75375	n/a	n/a	n/a	n/a	n/a	n/a	n/a	n/a	n/a
	run	10147	14521	20688	22124	n/a	n/a	n/a	n/a	n/a	n/a	n/a	n/a	n/a
	end	23710	19143	28430	30964	n/a	n/a	n/a	n/a	n/a	n/a	n/a	n/a	n/a
AG-PSK2S485FC11	start	18004	71456	95248	n/a	n/a	n/a	n/a	n/a	n/a	n/a	n/a	n/a	n/a
	run	10147	20518	28184	n/a	n/a	n/a	n/a	n/a	n/a	n/a	n/a	n/a	n/a
	end	23710	28174	39718	n/a	n/a	n/a	n/a	n/a	n/a	n/a	n/a	n/a	n/a

Spring Return Canted Torque Data

K2, K3, & K4 Sizes w/ Various Spring Cartridges, Canted Yoke

K2 Size - Spring 02

Canted Yoke

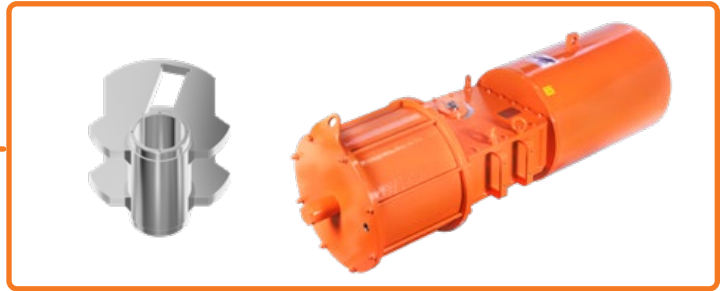

Torques

Model	Pos.	Spring Torque in-lbs	40 PSI	50 PSI	60 PSI	70 PSI	80 PSI	90 PSI	100 PSI	110 PSI	120 PSI	140 PSI	160 PSI	170 PSI
AG-PSK2S-235FC02	start	23401	n/a	n/a	n/a	n/a	n/a	n/a	23199	30661	36246	47418	58589	64175
	run	13184	n/a	n/a	n/a	n/a	n/a	n/a	4554	6614	8414	12014	15614	17413
	end	30781	n/a	n/a	n/a	n/a	n/a	n/a	3683	6413	9123	14544	19964	22675
AG-PSK2S255FC02	start	23401	n/a	n/a	n/a	n/a	n/a	28410	34987	41564	48141	61295	74448	81025
	run	13184	n/a	n/a	n/a	n/a	n/a	5889	8008	10128	12247	16485	20724	22843
	end	30781	n/a	n/a	n/a	n/a	n/a	5321	8512	11703	14895	21277	27660	30851
AG-PSK2S285FC02	start	23401	n/a	n/a	n/a	23795	34942	43157	51373	59588	67803	84234	97120	n/a
	run	13184	n/a	n/a	n/a	4969	7994	10641	13288	15935	18583	23877	28132	n/a
	end	30781	n/a	n/a	n/a	4551	8490	12476	16463	20449	24435	32408	38928	n/a
AG-PSK2S300FC02	start	23401	n/a	n/a	n/a	29113	42042	51145	60248	69351	78454	96660	n/a	n/a
	run	13184	n/a	n/a	n/a	6683	10282	13215	16148	19081	22014	27881	n/a	n/a
	end	30781	n/a	n/a	n/a	7132	11935	16352	20769	25186	29603	38437	n/a	n/a
AG-PSK2S335FC02	start	23401	n/a	n/a	37324	48675	60025	71376	82727	94078	73301	n/a	n/a	n/a
	run	13184	n/a	n/a	8761	12419	16076	19734	23391	27049	21248	n/a	n/a	n/a
	end	30781	n/a	n/a	9646	15153	20661	26169	31677	37185	29420	n/a	n/a	n/a
AG-PSK2S360FC02	start	23401	n/a	31996	47868	60976	74084	87192	100301	n/a	n/a	n/a	n/a	n/a
	run	13184	n/a	7388	12159	16383	20606	24830	29054	n/a	n/a	n/a	n/a	n/a
	end	30781	n/a	7952	14762	21123	27483	33844	40204	n/a	n/a	n/a	n/a	n/a
AG-PSK2S385FC02	start	23401	n/a	44179	59171	74163	89155	79221	n/a	n/a	n/a	n/a	n/a	n/a
	run	13184	n/a	10970	15801	20632	25463	22932	n/a	n/a	n/a	n/a	n/a	n/a
	end	30781	n/a	12972	20246	27521	34796	31713	n/a	n/a	n/a	n/a	n/a	n/a
AG-PSK2S435FC02	start	23401	45774	64913	69271	n/a	n/a	n/a	n/a	n/a	n/a	n/a	n/a	n/a
	run	13184	11484	17651	19502	n/a	n/a	n/a	n/a	n/a	n/a	n/a	n/a	n/a
	end	30781	13746	23033	26306	n/a	n/a	n/a	n/a	n/a	n/a	n/a	n/a	n/a
AG-PSK2S485FC02	start	23401	64385	88176	n/a	n/a	n/a	n/a	n/a	n/a	n/a	n/a	n/a	n/a
	run	13184	17481	25147	n/a	n/a	n/a	n/a	n/a	n/a	n/a	n/a	n/a	n/a
	end	30781	22776	34321	n/a	n/a	n/a	n/a	n/a	n/a	n/a	n/a	n/a	n/a

AG Series Technical Brochure

Max-Air Technology Inc. | Rotary Actuators & Valve Automation Solutions



maxairtech.com

K2 Size - Spring 21

Canted Yoke



Torques

Model	Pos.	Spring Torque in-lbs	40 PSI	50 PSI	60 PSI	70 PSI	80 PSI	90 PSI	100 PSI	110 PSI	120 PSI	140 PSI	160 PSI	170 PSI
AG-PSK2S235FC21	start	30300	n/a	n/a	n/a	n/a	n/a	n/a	n/a	n/a	n/a	39117	50289	55874
	run	16966	n/a	n/a	n/a	n/a	n/a	n/a	n/a	n/a	n/a	8232	11831	13631
	end	39082	n/a	n/a	n/a	n/a	n/a	n/a	n/a	n/a	n/a	7645	13065	15776
AG-PSK2S255FC21	start	30300	n/a	n/a	n/a	n/a	n/a	n/a	n/a	21750	39840	52994	66148	72725
	run	16966	n/a	n/a	n/a	n/a	n/a	n/a	n/a	4454	8465	12703	16942	19061
	end	39082	n/a	n/a	n/a	n/a	n/a	n/a	n/a	3931	7996	14378	20761	23952
AG-PSK2S285FC21	start	30300	n/a	n/a	n/a	n/a	n/a	n/a	39661	51287	59503	75934	92364	100580
	run	16966	n/a	n/a	n/a	n/a	n/a	n/a	8867	12153	14800	20095	25389	28036
	end	39082	n/a	n/a	n/a	n/a	n/a	n/a	9102	13550	17536	25509	33482	37468
AG-PSK2S300FC21	start	30300	n/a	n/a	n/a	n/a	n/a	42844	51947	61050	70153	88359	102794	n/a
	run	16966	n/a	n/a	n/a	n/a	n/a	9433	12366	15299	18232	24099	28888	n/a
	end	39082	n/a	n/a	n/a	n/a	n/a	9453	13870	18287	22704	31538	38901	n/a
AG-PSK2S335FC21	start	30300	n/a	n/a	n/a	35725	51725	63076	74426	85777	67272	n/a	n/a	n/a
	run	16966	n/a	n/a	n/a	7898	12294	15952	19609	23267	18501	n/a	n/a	n/a
	end	39082	n/a	n/a	n/a	7967	13762	19270	24778	30286	24409	n/a	n/a	n/a
AG-PSK2S360FC21	start	30300	n/a	n/a	39567	52676	65784	78892	92000	n/a	n/a	n/a	n/a	n/a
	run	16966	n/a	n/a	8377	12600	16824	21048	25272	n/a	n/a	n/a	n/a	n/a
	end	39082	n/a	n/a	7863	14224	20584	26945	33305	n/a	n/a	n/a	n/a	n/a
AG-PSK2S385FC21	start	30300	n/a	33126	50870	65862	80854	72625	n/a	n/a	n/a	n/a	n/a	n/a
	run	16966	n/a	6761	12019	16850	21680	19926	n/a	n/a	n/a	n/a	n/a	n/a
	end	39082	n/a	5931	13348	20622	27897	26231	n/a	n/a	n/a	n/a	n/a	n/a
AG-PSK2S435FC21	start	30300	n/a	56613	75751	94890	n/a	n/a	n/a	n/a	n/a	n/a	n/a	n/a
	run	16966	n/a	13869	20036	26203	n/a	n/a	n/a	n/a	n/a	n/a	n/a	n/a
	end	39082	n/a	16134	25421	34708	n/a	n/a	n/a	n/a	n/a	n/a	n/a	n/a
AG-PSK2S485FC21	start	30300	56084	79876	85405	n/a	n/a	n/a	n/a	n/a	n/a	n/a	n/a	n/a
	run	16966	13699	21365	23745	n/a	n/a	n/a	n/a	n/a	n/a	n/a	n/a	n/a
	end	39082	15878	27422	31656	n/a	n/a	n/a	n/a	n/a	n/a	n/a	n/a	n/a

Spring Return Canted Torque Data

K2, K3, & K4 Sizes w/ Various Spring Cartridges, Canted Yoke

K2 Size - Spring 22

Canted Yoke

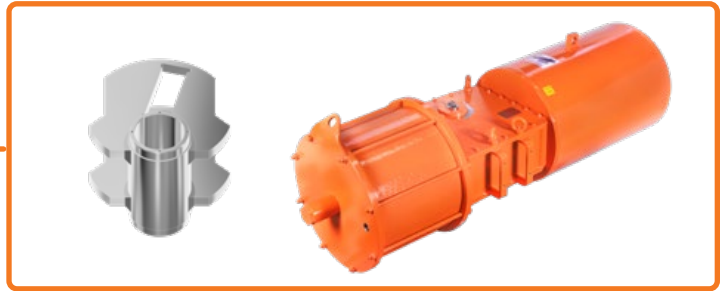

Torques

Model	Pos.	Spring Torque in-lbs	40 PSI	50 PSI	60 PSI	70 PSI	80 PSI	90 PSI	100 PSI	110 PSI	120 PSI	140 PSI	160 PSI	170 PSI
AG-PSK2S285FC22	start	34897	n/a	n/a	n/a	n/a	n/a	n/a	33972	44929	53145	69576	86006	94222
	run	19598	n/a	n/a	n/a	n/a	n/a	n/a	6512	9521	12169	17463	22757	25405
	end	45440	n/a	n/a	n/a	n/a	n/a	n/a	4989	8953	12940	20912	28885	32871
AG-PSK2S300FC22	start	34897	n/a	n/a	n/a	n/a	n/a	n/a	42034	54692	63795	82001	96637	n/a
	run	19598	n/a	n/a	n/a	n/a	n/a	n/a	9110	12667	15600	21467	26339	n/a
	end	45440	n/a	n/a	n/a	n/a	n/a	n/a	8901	13691	18108	26942	34449	n/a
AG-PSK2S335FC22	start	34897	n/a	n/a	n/a	30471	45367	56718	68069	79419	90770	n/a	n/a	n/a
	run	19598	n/a	n/a	n/a	5723	9662	13320	16977	20635	24292	n/a	n/a	n/a
	end	45440	n/a	n/a	n/a	4169	9166	14673	20181	25689	31197	n/a	n/a	n/a
AG-PSK2S360FC22	start	34897	n/a	n/a	n/a	41002	59426	72534	85642	n/a	n/a	n/a	n/a	n/a
	run	19598	n/a	n/a	n/a	9116	14192	18416	22640	n/a	n/a	n/a	n/a	n/a
	end	45440	n/a	n/a	n/a	9279	15987	22348	28708	n/a	n/a	n/a	n/a	n/a
AG-PSK2S385FC22	start	34897	n/a	n/a	44512	59504	74496	67572	n/a	n/a	n/a	n/a	n/a	n/a
	run	19598	n/a	n/a	9387	14218	19048	17835	n/a	n/a	n/a	n/a	n/a	n/a
	end	45440	n/a	n/a	8751	16025	23300	22577	n/a	n/a	n/a	n/a	n/a	n/a
AG-PSK2S435FC22	start	34897	n/a	50255	69393	88532	n/a	n/a	n/a	n/a	n/a	n/a	n/a	n/a
	run	19598	n/a	11237	17404	23571	n/a	n/a	n/a	n/a	n/a	n/a	n/a	n/a
	end	45440	n/a	11537	20824	30111	n/a	n/a	n/a	n/a	n/a	n/a	n/a	n/a
AG-PSK2S485FC22	start	34897	49726	73518	79917	n/a	n/a	n/a	n/a	n/a	n/a	n/a	n/a	n/a
	run	19598	11067	18733	21473	n/a	n/a	n/a	n/a	n/a	n/a	n/a	n/a	n/a
	end	45440	11281	22825	27688	n/a	n/a	n/a	n/a	n/a	n/a	n/a	n/a	n/a

AG Series Technical Brochure

Max-Air Technology Inc. | Rotary Actuators & Valve Automation Solutions



maxairtech.com

K2 Size - Spring 03

Canted Yoke

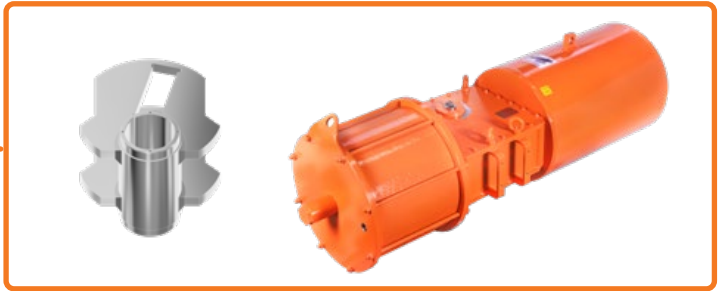

Torques

Model	Pos.	Spring Torque in-lbs	40 PSI	50 PSI	60 PSI	70 PSI	80 PSI	90 PSI	100 PSI	110 PSI	120 PSI	140 PSI	160 PSI	170 PSI
AG-PSK2S285FC03	start	35209	n/a	n/a	n/a	n/a	n/a	n/a	n/a	27858	50945	67375	83806	92021
	run	20015	n/a	n/a	n/a	n/a	n/a	n/a	n/a	6251	11751	17046	22340	24987
	end	47640	n/a	n/a	n/a	n/a	n/a	n/a	n/a	6453	12628	20601	28573	32560
AG-PSK2S300FC03	start	35209	n/a	n/a	n/a	n/a	n/a	n/a	40066	52492	61595	79801	94506	n/a
	run	20015	n/a	n/a	n/a	n/a	n/a	n/a	8737	12250	15183	21049	25935	n/a
	end	47640	n/a	n/a	n/a	n/a	n/a	n/a	8622	13379	17796	26630	34147	n/a
AG-PSK2S335FC03	start	35209	n/a	n/a	n/a	n/a	n/a	54517	65868	77219	88570	n/a	n/a	n/a
	run	20015	n/a	n/a	n/a	n/a	n/a	12902	16560	20217	23875	n/a	n/a	n/a
	end	47640	n/a	n/a	n/a	n/a	n/a	14362	19869	25377	30885	n/a	n/a	n/a
AG-PSK2S335FC03	start	35209	n/a	n/a	n/a	39184	57226	70334	83442	96550	75866	n/a	n/a	n/a
	run	20015	n/a	n/a	n/a	8772	13775	17999	22223	26446	21058	n/a	n/a	n/a
	end	47640	n/a	n/a	n/a	9021	15676	22036	28397	34757	28030	n/a	n/a	n/a
AG-PSK2S385FC03	start	35209	n/a	n/a	42312	57304	72296	87288	102280	n/a	n/a	n/a	n/a	n/a
	run	20015	n/a	n/a	8969	13800	18631	23462	28293	n/a	n/a	n/a	n/a	n/a
	end	47640	n/a	n/a	8439	15714	22988	30263	37537	n/a	n/a	n/a	n/a	n/a
AG-PSK2S435FC03	start	35209	n/a	44303	67193	86332	105471	n/a	n/a	n/a	n/a	n/a	n/a	n/a
	run	20015	n/a	10102	16987	23154	29321	n/a	n/a	n/a	n/a	n/a	n/a	n/a
	end	47640	n/a	10678	20512	29799	39086	n/a	n/a	n/a	n/a	n/a	n/a	n/a
AG-PSK2S485FC03	start	35209	n/a	71317	78018	n/a	n/a	n/a	n/a	n/a	n/a	n/a	n/a	n/a
	run	20015	n/a	18316	21113	n/a	n/a	n/a	n/a	n/a	n/a	n/a	n/a	n/a
	end	47640	n/a	22513	27419	n/a	n/a	n/a	n/a	n/a	n/a	n/a	n/a	n/a

Spring Return Canted Torque Data

K2, K3, & K4 Sizes w/ Various Spring Cartridges, Canted Yoke

K2 Size - Spring 31

Canted Yoke



Torques

Model	Pos.	Spring Torque in-lbs	40 PSI	50 PSI	60 PSI	70 PSI	80 PSI	90 PSI	100 PSI	110 PSI	120 PSI	140 PSI	160 PSI	170 PSI
AG-PSK2S300FC31	start	42107	n/a	n/a	n/a	n/a	n/a	n/a	32640	44193	53296	71502	89708	98811
	run	23797	n/a	n/a	n/a	n/a	n/a	n/a	5353	8468	11401	17267	23134	26067
	end	55939	n/a	n/a	n/a	n/a	n/a	n/a	2449	6480	10897	19731	28565	32982
AG-PSK2S335FC31	start	42107	n/a	n/a	n/a	n/a	n/a	46219	57570	68920	80271	n/a	n/a	n/a
	run	23797	n/a	n/a	n/a	n/a	n/a	9120	12778	16436	20093	n/a	n/a	n/a
	end	55939	n/a	n/a	n/a	n/a	n/a	7463	12970	18478	23986	n/a	n/a	n/a
AG-PSK2S360FC31	start	42107	n/a	n/a	n/a	n/a	n/a	62035	75143	88252	69839	n/a	n/a	n/a
	run	23797	n/a	n/a	n/a	n/a	n/a	14217	18441	22664	18311	n/a	n/a	n/a
	end	55939	n/a	n/a	n/a	n/a	n/a	15137	21498	27858	23019	n/a	n/a	n/a
AG-PSK2S385FC31	start	42107	n/a	n/a	n/a	43615	63997	78989	93981	n/a	n/a	n/a	n/a	n/a
	run	23797	n/a	n/a	n/a	9284	14849	19680	24511	n/a	n/a	n/a	n/a	n/a
	end	55939	n/a	n/a	n/a	8798	16089	23364	30639	n/a	n/a	n/a	n/a	n/a
AG-PSK2S435FC31	start	42107	n/a	n/a	58895	78033	97172	n/a	n/a	n/a	n/a	n/a	n/a	n/a
	run	23797	n/a	n/a	13205	19372	25539	n/a	n/a	n/a	n/a	n/a	n/a	n/a
	end	55939	n/a	n/a	13613	22900	32187	n/a	n/a	n/a	n/a	n/a	n/a	n/a
AG-PSK2S485FC31	start	42107	n/a	63019	70855	n/a	n/a	n/a	n/a	n/a	n/a	n/a	n/a	n/a
	run	23797	n/a	14534	17849	n/a	n/a	n/a	n/a	n/a	n/a	n/a	n/a	n/a
	end	55939	n/a	15615	21465	n/a	n/a	n/a	n/a	n/a	n/a	n/a	n/a	n/a

AG Series Technical Brochure

Max-Air Technology Inc. | Rotary Actuators & Valve Automation Solutions



maxairtech.com

K2 Size - Spring 32

Canted Yoke



Torques

Model	Pos.	Spring Torque in-lbs	40 PSI	50 PSI	60 PSI	70 PSI	80 PSI	90 PSI	100 PSI	110 PSI	120 PSI	140 PSI	160 PSI	170 PSI
AG-PSK2S335FC32	start	46703	n/a	n/a	n/a	n/a	n/a	n/a	47370	62561	73911	96613	n/a	n/a
	run	26429	n/a	n/a	n/a	n/a	n/a	n/a	9578	13804	17461	24776	n/a	n/a
	end	62299	n/a	n/a	n/a	n/a	n/a	n/a	8245	13882	19390	30406	n/a	n/a
AG-PSK2S360FC32	start	46703	n/a	n/a	n/a	n/a	n/a	55675	68783	81892	65220	n/a	n/a	n/a
	run	26429	n/a	n/a	n/a	n/a	n/a	11585	15809	20033	16400	n/a	n/a	n/a
	end	62299	n/a	n/a	n/a	n/a	n/a	10541	16902	23262	19681	n/a	n/a	n/a
AG-PSK2S385FC32	start	46703	n/a	n/a	n/a	38359	57637	72629	87621	n/a	n/a	n/a	n/a	n/a
	run	26429	n/a	n/a	n/a	7109	12217	17048	21879	n/a	n/a	n/a	n/a	n/a
	end	62299	n/a	n/a	n/a	5000	11493	18768	26043	n/a	n/a	n/a	n/a	n/a
AG-PSK2S435FC32	start	46703	n/a	n/a	52535	71674	90813	82853	n/a	n/a	n/a	n/a	n/a	n/a
	run	26429	n/a	n/a	10573	16740	22907	21647	n/a	n/a	n/a	n/a	n/a	n/a
	end	62299	n/a	n/a	9017	18304	27591	27111	n/a	n/a	n/a	n/a	n/a	n/a
AG-PSK2S485FC32	start	46703	n/a	52320	65365	n/a	n/a	n/a	n/a	n/a	n/a	n/a	n/a	n/a
	run	26429	n/a	11173	15577	n/a	n/a	n/a	n/a	n/a	n/a	n/a	n/a	n/a
	end	62299	n/a	10647	17498	n/a	n/a	n/a	n/a	n/a	n/a	n/a	n/a	n/a

MAX-AIR TECHNOLOGY

The Best Way To Automate Your Process



Your nearest Max-Air dealer can be found at:



maxairtech.com

Max-Air Technology, Inc. • 114 Resource Drive • Wentzville, MO 63385 • United States of America
Tel +1.636.272.4934 • Toll Free 888.842.9998 • Fax 636.272.4937 • www.maxairtech.com • info@maxairtech.com

© Max-Air Technology, Inc. 2020



R: 10/21/21