

Data Sheet for Precision Potentiometer

Multiturn Wirewound Potentiometer

Series ALS25



The ALS25 series potentiometers are used as multiturn sensors with outstanding linearity and resolution for measuring ranges from 3 to 20 revolutions.

- Multiturn 3..20 turns
- Optional rear shaft
- Optional tandem version
- On request limit switch (CW, CCW)

Despite the compact housing diameter of only 25 mm, the potentiometer offers an angular range of up to 20 rev. and exceptional additional options such as galvanically isolated limit switches for the limit positions and up to 5 taps of the resistance element. For applications with the requirement for redundant and / or galvanically isolated signals, the tandem variant can be selected.

Electrical Data	3-turn	5-turn	10-turn	15-turn	20-turn
Effective electrical angle of rotation 1.)	1080° ±5°	1800° ±5°	3600° ±5°	5400° ±5°	7200° ±5°
Total resistance 1.)	0.1..50 kOhm	0.1..100 kOhm	0.1..200 kOhm		
Resistance tolerance	±3% (±1%)				
Independent linearity (best straight line) 1.)	±0.25%	±0.25% (±0.2%) [±0.25% R< 5k]	±0.25% (±0.1%) [±0.15% R< 5k]		
Theoretical resolution 1.)	Depending on the resistance value (see table)				
Backlash (Hysteresis) 1.)	≤ 2°				
Max. / recommended wiper current 1.)	10 µA / 2 µA				
Power rating @ 70°C (0W @ 105°C)	1 W	1.5 W	2 W		
Insulation Voltage 1.)	1000 VAC, 1min				
Insulation Resistance 1.)	100 MOhm @ 1000 VDC				

Mechanical Data, Environmental Conditions, Miscellaneous	3-turn	5-turn	10-turn	15-turn	20-turn
Mechanical angle of rotation 1.)	1080° +10°	1800° +10°	3600° +10°	5400° +10°	7200° +10°
Lifetime (90% el. eff. angle half sine) 2.)	0.6 Mio. rev.	1 Mio. rev.	2 Mio. rev.		
Max. operational speed	40 rev. / min.				
Bearing	2 x ball bearing				
Operational torque @ ambient temperature 1.) 2.)	5 Nmm				
End stop torque 1.) 2.)	90 Ncm				
Operating temperature range	-20 °C up to +105 °C				
Storage temperature range	-55 °C up to +105 °C				
Protection grade (IEC 60529)	IP40				
Vibration (IEC 68-2-6, Test Fc)	15g 10Hz up to 2000Hz x 12h				
Shock (IEC 68-2-27, Test Ea)	49g @ 11 ms x 18				
Housing diameter	25 mm				
Housing depth	30.5 mm		39 mm	47.5 mm	56.5 mm
Shaft diameter	4.00 mm				
Shaft type	Solid shaft				

Data Sheet for Precision Potentiometer

Multiturn Wirewound Potentiometer

Series ALS25

Mechanical Data, Environmental Conditions, Miscellaneous	3-turn	5-turn	10-turn	15-turn	20-turn
Max. radial load	≤1 N				
Max. axial load	≤1 N				
Connection type	Soldering lugs				
Connection position	Radial				
Sensor mounting	Bushing				
Mass	ca. 50 g		ca. 60 g	ca. 70 g	ca. 80 g
Fastening parts included in delivery	3 x servo clamps SFN2				
Material shaft	Stainless steel				
Material housing	Plastic				

1.) According IEC 60393

2.) Determined by climatic conditions according to IEC 68-1, para. 5.3.1 without load collectives

Please note: Max. permissible supply voltage <75 VDC respectively <50 VAC in addition the max. power rating must be observed

Number of wire turns / resolution											
Resistance value Ohm	100	200	500	1k	2k	5k	10k	20k	50k	100k	200k
Number of windings (ALS25-03)	N/A	N/A	N/A	N/A	N/A	N/A	N/A	N/A	N/A	-	-
Number of windings (ALS25-05)	1300	1700	2000	2400	2500	3200	4000	5000	7000	8800	-
Number of windings (ALS25-10)	2000	2600	3100	4000	4800	5000	6500	8000	10000	14000	18000
Number of windings (ALS25-15)	N/A	N/A	N/A	N/A	N/A	N/A	N/A	N/A	N/A	N/A	N/A
Number of windings (ALS25-20)	N/A	N/A	N/A	N/A	N/A	N/A	N/A	N/A	N/A	N/A	N/A

Resolution in degrees e. g. R5k 5-turn = $1800^\circ / 3200 = 0.553^\circ$ per turn of the resistance wire

Data Sheet for Precision Potentiometer



Multiturn Wirewound Potentiometer

Series ALS25

Drawing

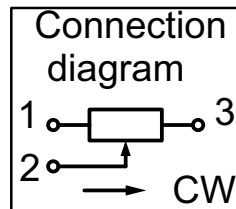
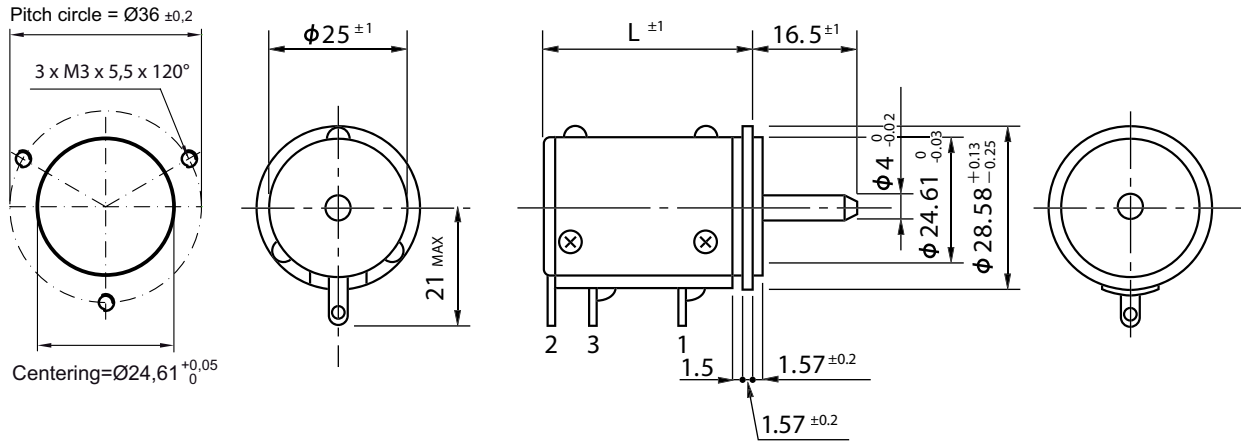

Model No.	L
ALS2503/05	30.5
ALS2510	39
ALS2515	47.5
ALS2520	56.5

Dimensions in mm

On request: limit switch

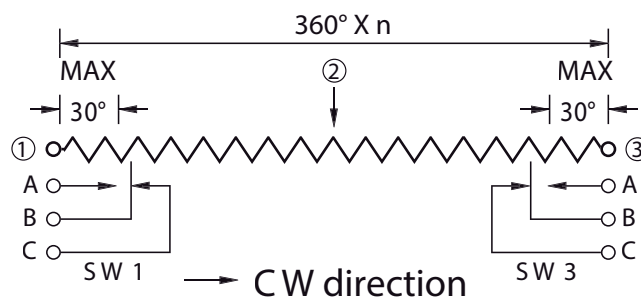
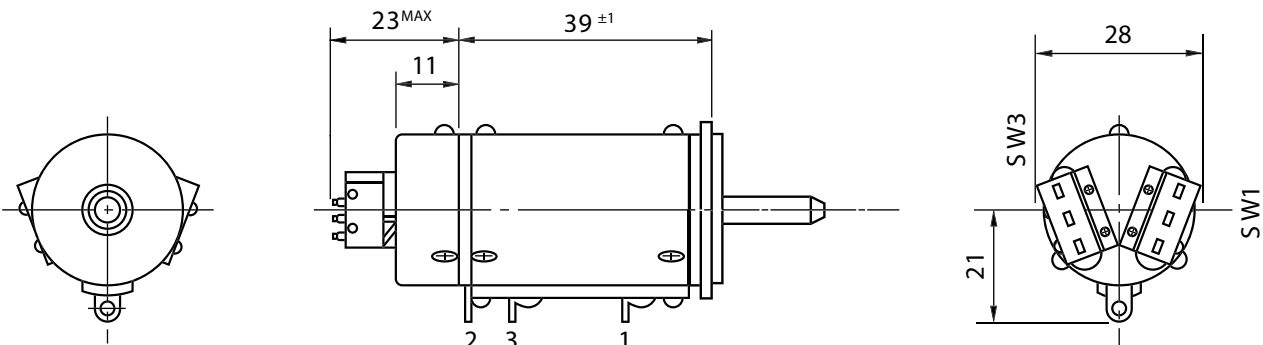

Unless otherwise specified, the limit-switch is of inscription type on both ends.

- Rating of limit-switch 1A, 125V.A.C. (resistance load)
- Life expectancy of limit-switch: 50,000 operations
- Operating temperature range: -55° C..+105° C

NOTE: In case of model ALS25 with 15..20 turns the limit-switch adaptor is also available as a special version.

On Request: Special machining on shaft

Slot

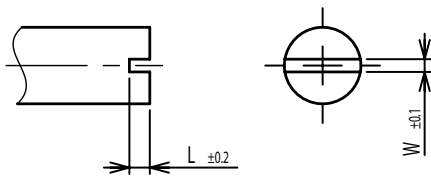

Groove

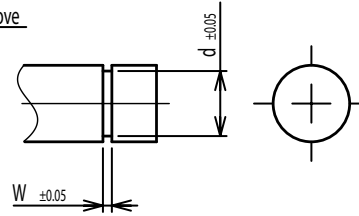

Flat

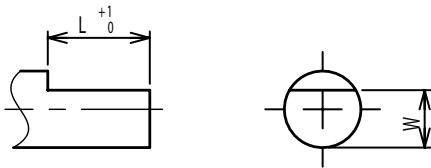

Round top

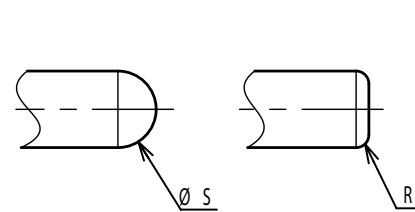

Double side flat

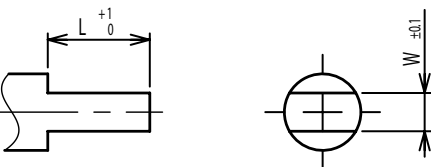

Counterbore hole

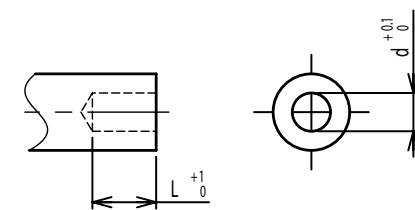

Step

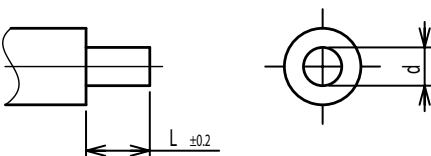

Counterbore screw hole

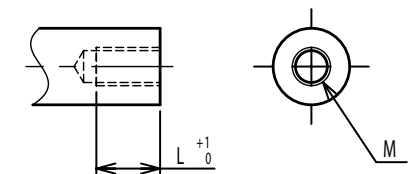

Screw Thread

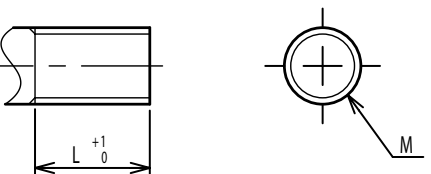

Pin hole

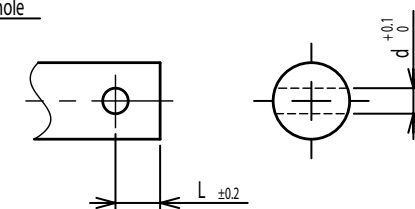

Knurled(Parallel)



Screw thread inside hole

