

# Data Sheet for Precision Potentiometer

Conductive Plastic Potentiometer

Series MP10/11



The MP10/11 potentiometers in 13 mm housing are for applications in which a miniaturized sensor with good lifespan characteristics is important.

- Miniature housing with Ø13 mm only
- Ideal for confined spaces
- With or without mechanical end stop (310° / 360°)
- Lifespan 5 Mio.
- Robust metal housing
- Optional rear shaft and center tap

The conductive plastic potentiometer MP10/11 (MP11 with mech. endstop) with only Ø13 mm miniature housing and bushing is ideal for confined spaces

Note: The versions MP11 with stop are also used as manual control

Electrical Data	MP10	MP11
Effective electrical angle of rotation 1.)	300° ±5°	
Total resistance 1.)	0.5 kOhm up to 100 kOhm	
Resistance tolerance	±15% (±10%)	
Independent linearity (best straight line) 1.)	±2% (±1%)	
Theoretical resolution	Nearly infinite	
Backlash (Hysteresis) 1.)	≤ 0.5°	
Max. / recommended wiper current 1.)	10 µA / 2 µA	
Power rating @ 70°C (0W @ 105°C)	0.2 W	
Insulation Voltage 1.)	500 VAC, 1min	
Insulation Resistance 1.)	1000 MOhm @ 500 VDC	

Mechanical Data, Environmental Conditions, Miscellaneous	MP10	MP11
Mechanical angle of rotation 1.)	360° without stop	310° +10° with stop
Lifetime (90% el. eff. angle half sine) 2.)	5 Mio. rotations	
Max. operational speed	400 rev. / min.	
Bearing	Sleeve bearing	
Operational torque @ ambient temperature 1.) 2.)	2 Nmm	
End stop torque 1.) 2.)	-	30 Ncm
Operating temperature range	-55 °C up to +105 °C	
Storage temperature range	-55 °C up to +105 °C	
Protection grade (IEC 60529)	IP40	
Vibration (IEC 68-2-6, Test Fc)	15g 10Hz up to 2000Hz x 12h	
Shock (IEC 68-2-27, Test Ea)	49g @ 11 ms x 18	
Housing diameter	13 mm	
Housing depth	10 mm	
Shaft diameter	3 mm	
Shaft type	Solid shaft	

# Data Sheet for Precision Potentiometer

Conductive Plastic Potentiometer

Series MP10/11

Mechanical Data, Environmental Conditions, Miscellaneous	MP10	MP11
Max. radial load	≤1 N	
Max. axial load	≤1 N	
Connection type	Gold plated soldering pins	
Connection position	Axial	
Sensor mounting	Bushing	
Mass	8 g	
Fastening parts included in delivery	Nut, toothed washer	
Fastening torque mounting nut	100 Ncm	
Material shaft	Stainless steel	
Material housing	Steel	

1.) According IEC 60393

2.) Determined by climatic conditions according to IEC 68-1, para. 5.3.1 without load collectives

Please note: Max. permissible supply voltage <75 VDC respectively <50 VAC in addition the max. power rating must be observed

Order code							
Description	Selection: <b>standard=black/bold</b> , possible <i>options=grey/italic</i>						
<b>Series:</b>	<b>MP</b>						
<b>Angle of rotation with / without mech. stop:</b>							
<b>Without stop</b>	<b>10</b>						
<b>With stop</b>	<b>11</b>						
<b>Resistance value:</b>							
<i>Option 500 Ohm</i>			<i>R500</i>				
<b>1 kOhm</b>			<b>R1k</b>				
<i>Option 2 kOhm</i>			<i>R2k</i>				
<b>5 kOhm</b>			<b>R5k</b>				
<b>10 kOhm</b>			<b>R10k</b>				
<i>Option 20 kOhm</i>			<i>R20K</i>				
<i>Option 50 kOhm</i>			<i>R50K</i>				
<i>Option 100 kOhm</i>			<i>R100K</i>				
<i>Option rear shaft:</i>							
<i>Standard Ø1,00 x 10 mm</i>					<i>RA</i>		
<i>Shaft length in mm</i>					<i>RAxx,xx</i>		
<b>Resistance tolerance:</b>							
<b>±15%</b>						<b>W15%</b>	
<i>Option: ±10%</i>						<i>W10%</i>	
<b>Independent linearity:</b>							
<b>±2%</b>							<b>L2%</b>
<i>Option ±1%</i>							<i>L1%</i>
<i>Option center tap:</i>							<i>CT</i>
<b>Front shaft:</b>							
<b>Standard Ø3,00 x 20 mm</b>							-
<i>Option Ø 3,175 x 20 mm</i>							<i>DM3,175</i>
<i>Option shaft length in mm</i>							<i>Ax,xx</i>
<i>Option shaft diameter in mm (≤3,175 mm)</i>							<i>DMx,xx</i>

**For higher quantities or on-going demand, additional options are available as described below on request**

For Example: Sealed housing case, special electrical and mechanical angles of rotation, and special resistance and linearity tolerances. Furthermore we can mount gear wheels or attach cable assemblies with or without connectors and much more.

# Data Sheet for Precision Potentiometer



Conductive Plastic Potentiometer

Series MP10/11

## Drawing

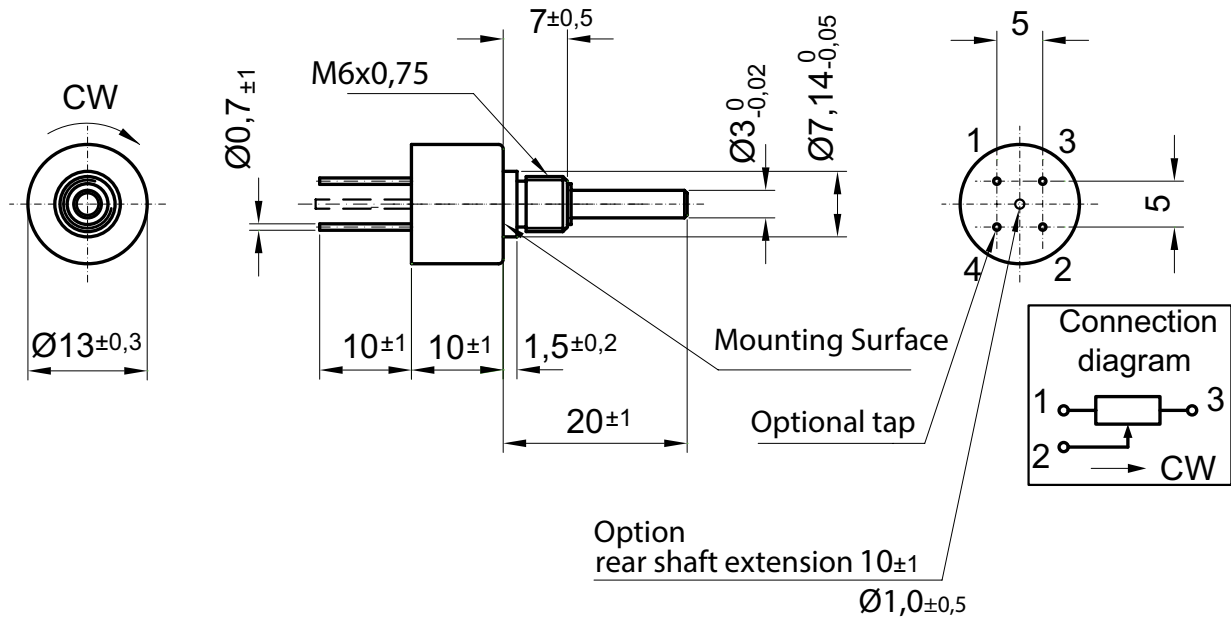

**On Request: Special machining on shaft**

Slot

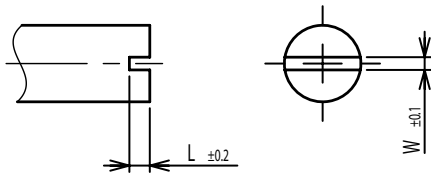

Groove

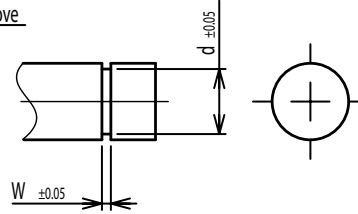

Flat

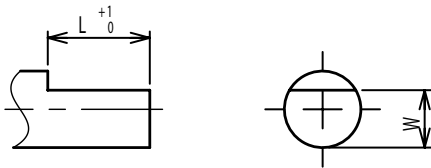

Round top

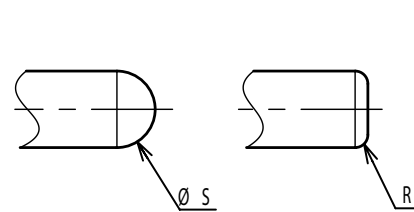

Double side flat

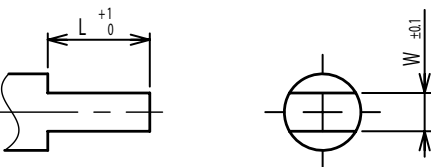

Counterbore hole

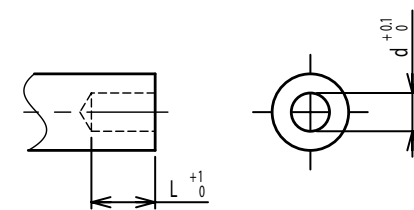

Step

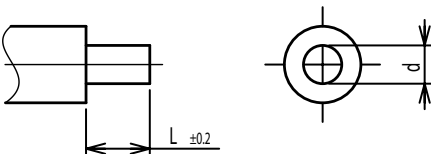

Counterbore screw hole

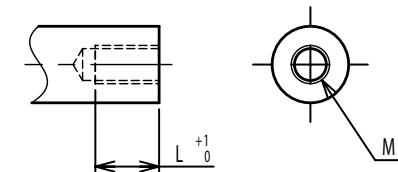

Screw Thread

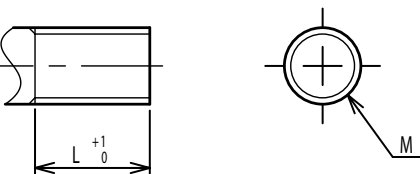

Pin hole

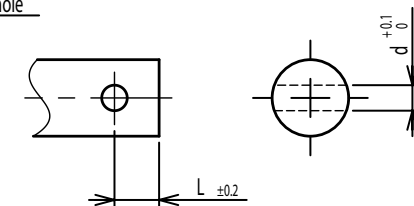

Knurled(Parallel)



Screw thread inside hole

