

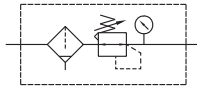

Symbol



Specification

Model	MAFR200	
Bore No.	6A	8A
Port size	1/8	1/4
Medium	Air	
Operating pressure range (*)	0.05~1 MPa	
Proof pressure	1.5 MPa	
Regulated pressure range	Standard: 0.05~0.85 MPa	
Ambient temperature	- 5~+60°C (No freezing)	
Filter element	Standard: 40µm, Option: 5 µm	
Drain capacity	9.5 cm ³ , 25 cm ³ (MAFR200L)	
Attachment	Pressure gauge (PG-40), L-type bracket	
Weight	257 g, 226 g (MAFR200L)	

* Standard unit contains semi-auto-drain function when operating pressure below 0.05 MPa.

Order example

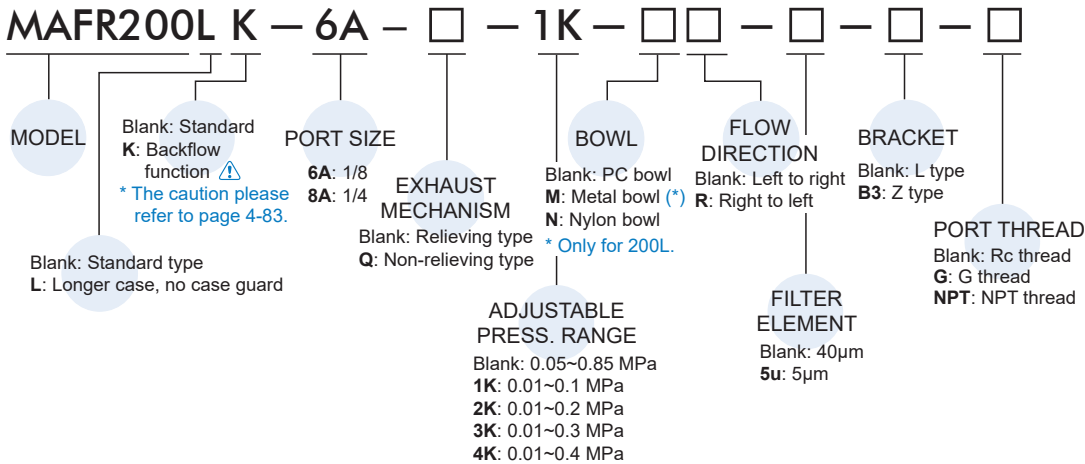

* Standard type regulator can not release the outlet pressure completely, even if inlet pressure was cut off, and the backflow function (K) must be applied to completely remove the residual pressure.

* The (Q) non-relieving type regulator is used. When the output pressure is higher than the set pressure, the output pressure will not flow out through the exhaust hole.

Flow feature

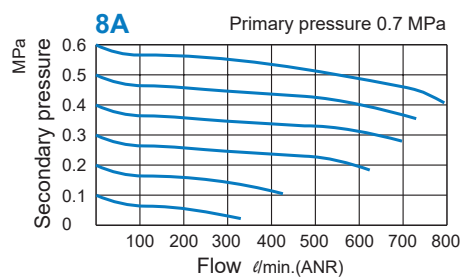
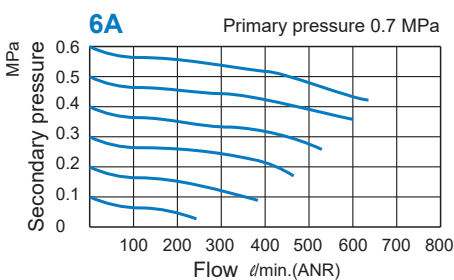

MAFR200 Dimensions

AIR UNIT (F.R.UNIT)



MAFR200-B3

Z type bracket

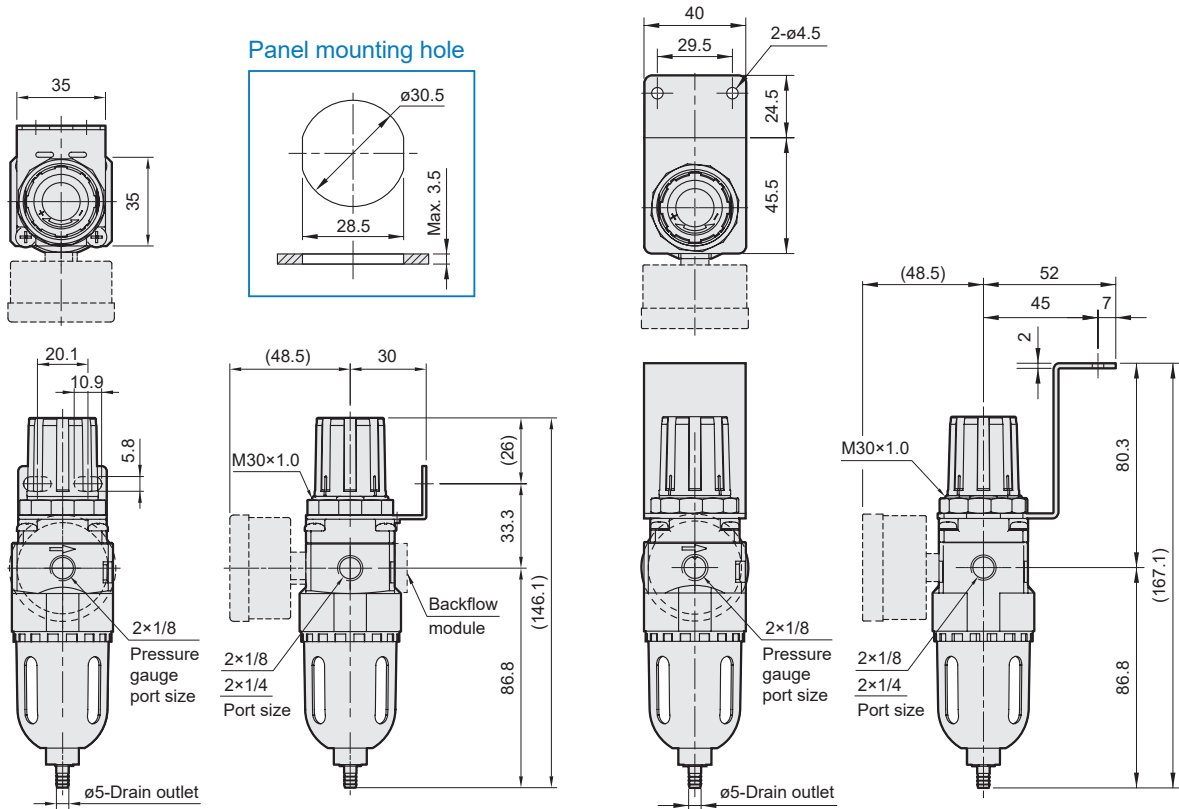

MAFR200L-M

Metal bowl + L type bracket

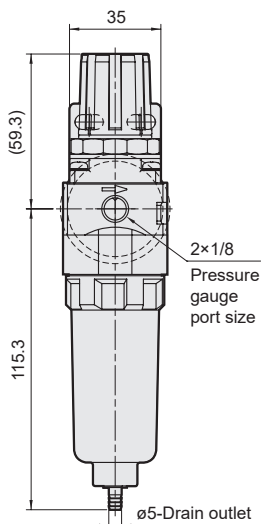

MAFR200L

L type bracket

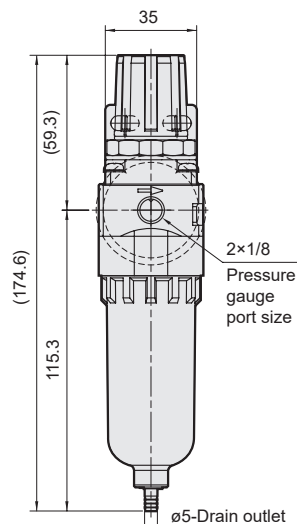

MAFR200L-B3

Z type bracket

